

Arteor™
Preterminated HDMI socket

Cat. No(s): 5 720 96 - 5 722 99 - 5 724 76
5 725 17/18/19/96/99
5 735 96

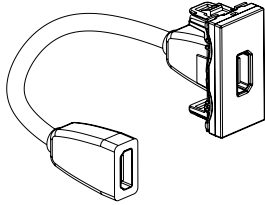

5 720 96 - 5 725 17/18/96

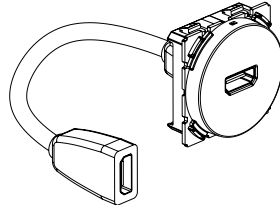

5 724 76 - 5 725 19 - 5 735 96

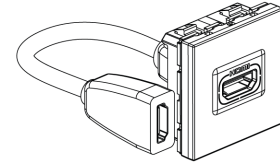

5 722 99 - 5 725 99

1. USE

HDMI sockets are used to transmit High Definition digital audio/video streams between a source (computer, DVD ou Blu-Ray player, etc) and a compatible receiver (TV, video projector, etc).
 To ensure a high-quality result, the connection between the two devices should not exceed a certain distance (see audio/video characteristics table). For longer connections, it is necessary to provide a booster system in the installation.
 The connectors are type A and conform to the HDMI standard.
 Equipped with a 15 cm cord and 2 female connectors.

2. RANGE

Description	Cat. No.	Modules	Fixing method	Connection method
Preterminated HDMI socket White cover plate - round	5 724 76	2	Clips	Plug-in
Preterminated HDMI socket Magnesium cover plate - round	5 735 96	2	Clips	Plug-in
Preterminated HDMI socket Soft Alu cover plate - round	5 725 19	2	Clips	Plug-in
Preterminated HDMI socket White cover plate - square	5 722 99	2	Clips	Plug-in
Preterminated HDMI socket Magnesium cover plate - square	5 725 99	2	Clips	Plug-in
Preterminated HDMI socket White cover plate - square	5 720 96	1	Clips	Plug-in
Preterminated HDMI socket Soft Alu cover plate - square	5 725 17	1	Clips	Plug-in
Preterminated HDMI socket Champagne cover plate - square	5 725 18	1	Clips	Plug-in
Preterminated HDMI socket Magnesium cover plate - square	5 725 96	1	Clips	Plug-in

3. DIMENSIONS

5 722 99 - 5 724 76 - 5 725 19/99 - 5 735 96

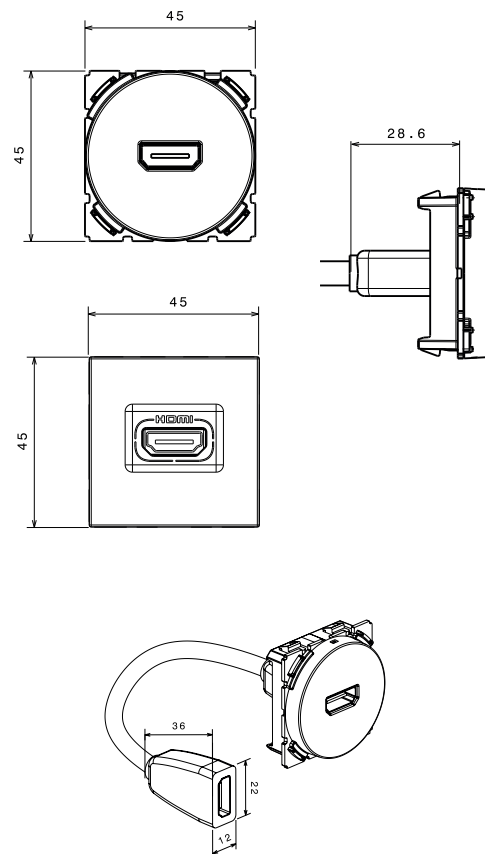

3. DIMENSIONS (continued)

5 720 96 - 5 725 17/18/96

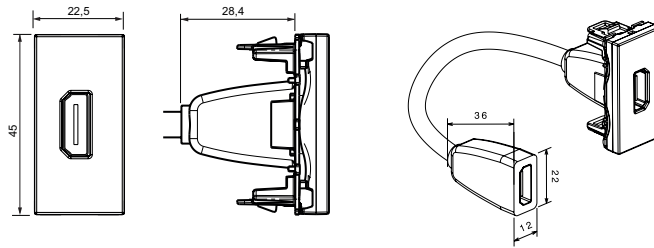

4. TECHNICAL CHARACTERISTICS

4.1 Audio/Video characteristics

Values indicated for an installation set up in accordance with best practice and connected in compliance with existing standards. Any additional accessories and cords should comply with these same criteria.

HDMI version 1.4

Max. resolution (pixels) : 1080 p

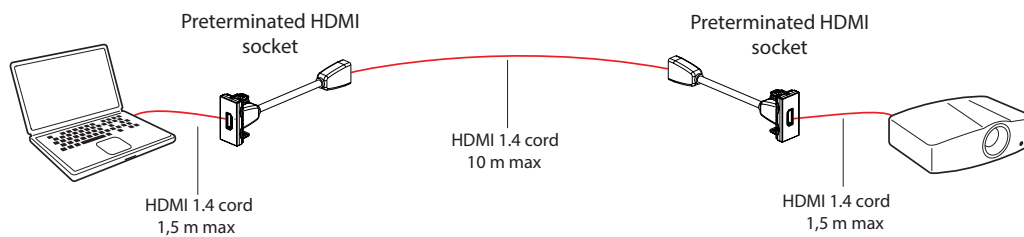

HDMI version 2.0

Max. resolution (pixels) : 2160p

Format 16/9 : 2160p, 60Hz, RGB

Format 21/9 : 3840 x 2160p, 60Hz, RGB

Configuration 1

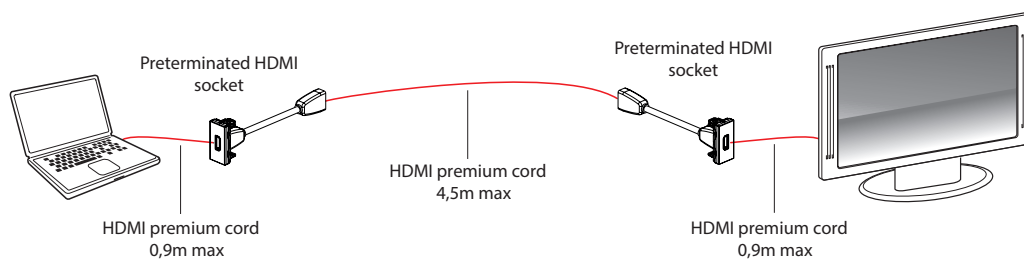

Configuration 2

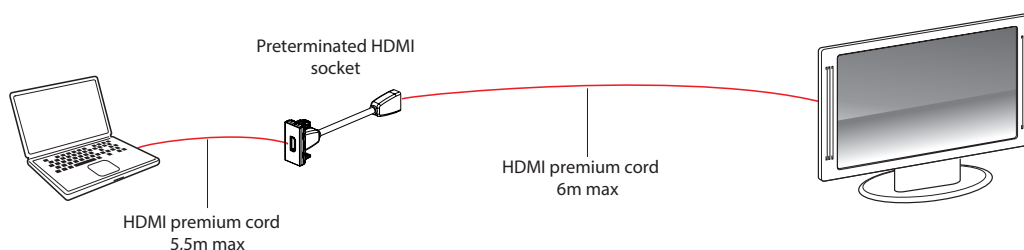

4. TECHNICAL CHARACTERISTICS *(continued)*

4.2 Mechanical characteristics

Min. depth of box : 50 mm
Impact tests : IK 04
Penetration by solid/liquid matter : IP 40

4.3 Material characteristics

Cover plate : ABS (RAL 9003)
Self-extinguishing : 650°C/30 s

4.4 Climate characteristics

Storage temperature : - 10°C to + 70°C
Usage temperature : - 5°C to + 50°C

5. CARE

Clean the surface with a cloth.
Do not use acetone, tar-removing cleaning agents or trichloroethylene.

5.1 Resistance to cleaning products

Resistant to the following products : - Hexane (EN 60669-1)
- Methylated spirit
- Soapy water
- Diluted ammonia
- Bleach diluted to 10%
- Window-cleaning products
- Pre-impregnated wipes

5.2 Resistance to hospital-grade cleaning products

Resistant to the following products : - Anios
- Surfanios
- Bactylsine
- Hydrogen peroxide
(35% oxygenated water)

Caution : Always test before using other special cleaning products.

6. STANDARDS AND APPROVALS

Compliance with installation and manufacturing standards.
Refer to e. catalogue.