

Mosaic™
LCS² Cat. 6A STP RJ 45 socket

Cat. No(s): 0 765 08/24/25/73/76/84/99
0 791 73L/76/76L - 0 794 73/76

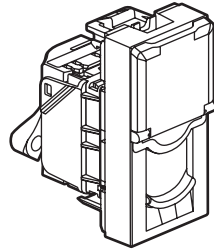

0 765 73

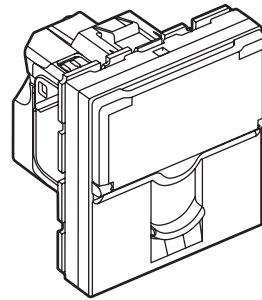

0 794 76

1. USE

Cat. 6A RJ 45 terminal socket for high speed connection to a network.
 Enables data transmission at 10 Gbit/s.
 Socket is used with F/UTP, S/FTP, F/FTP.
 The mechanism can be flush-mounted or surface-mounted in 40 mm depth box min.
 To be equipped with frame and plates. Fixing with clips.

Socket 0 765 84 : This product is made of silver-ion based antimicrobial* material.
 This technology eliminates bacteria, fungi and viruses without creating any immunisation or resistance effects (physical, rather than chemical, destruction).
 Particularly suitable for healthcare establishments (hospitals, clinics, nursing homes, laboratories, waiting rooms, etc.) and more generally for areas subject to hygiene restrictions (industrial, shared and restaurant kitchens, waste, etc.).
 This product offers an additional way of ensuring the non-proliferation of bacteria, fungi and viruses without interfering with cleaning protocols.

2. RANGE

Description	White	Aluminium	White antimicrobial*	Black mat
Cat. 6A STP RJ 45 - Metal shielding - 1 module	0 765 73	0 794 73	0 765 84	0 791 73L
Cat. 6A STP RJ 45 - Metal shielding - 2 modules	0 765 76	0794 76	-	0 791 76L
Cat. 6A STP RJ 45 - Metal shielding - 2 modules - with green shutter	0 765 24	-	-	-
Cat. 6A STP RJ 45 - Metal shielding - 2 modules - with orange shutter	0 765 25	-	-	-
Cat. 6A STP RJ 45 - Metal shielding - with controlled access - 2 modules Supplied with 2 keys for 5 sockets - with red shutter	0 765 99	-	-	-
Cat. 6A STP RJ 45 - Metal shielding - 45° socket - 2 modules	0 765 08	-	-	-

Presentation

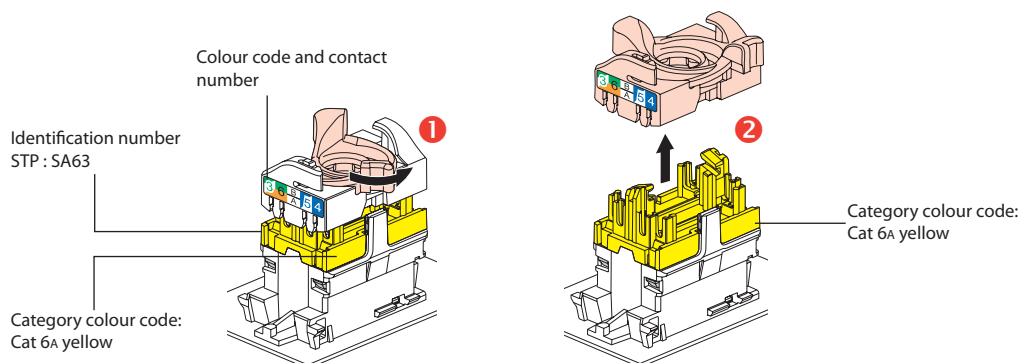

3. DIMENSIONS (mm)

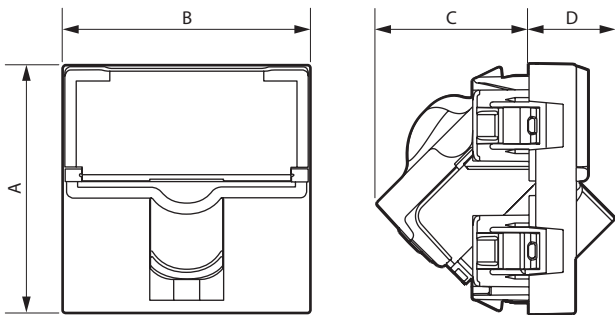

References	A	B	C	D
0 765 73/84 - 0 794 73	45	22.5	31	15.5
0 765 76/24/25 - 0 794 76 - 0 791 76	45	45	31	15.5
0 765 99	45	45	31	37.5
0 765 08	45	45	27.5	15.5

4. CONNECTION

Accepts the following cable connectors:
RJ 11 (4 contacts), RJ 12 (6 contacts), RJ 45 (9 contacts).

Double colour code T568A and T568B on terminals:
STP 9 contacts 360° screen

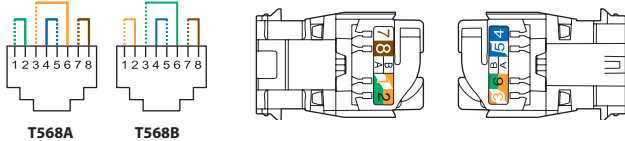

Conductors supported:

- Solid/Stranded : 0.4 to 0.65 mm, AWG 26 to 22
- Polyethylene conductor insulation: Ø 0.85 to 1.7 mm on insulation

RJ 45 connectors are equipped with a locking nut that does not require the use of a specific tool and which enables re-cabling in the event of error.

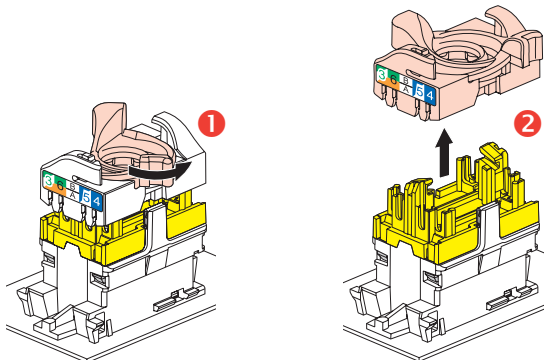

4. CONNECTION (continued)

This system allows the wire pairs to be spread easily before mounting them on the connector.

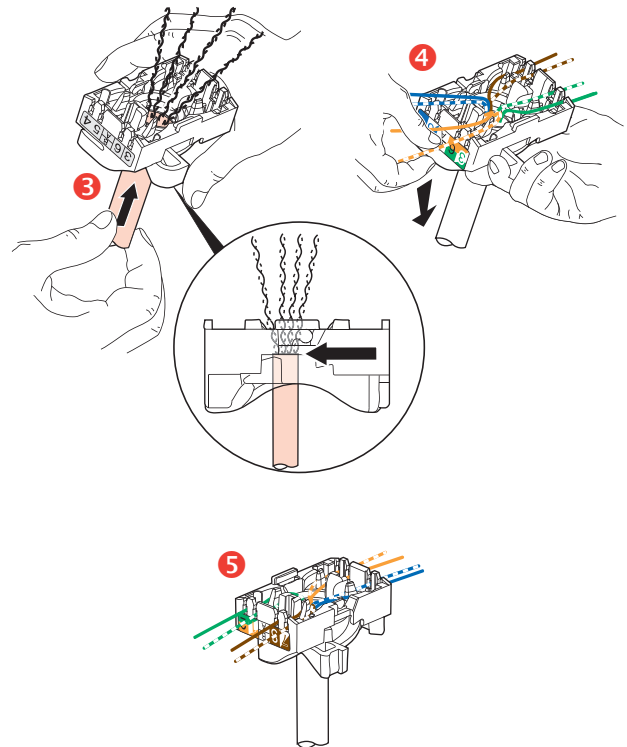

Spreading cables ensures that each pair is separated by the specified 13 mm.
Spreading pairs by 90° in relation to the cable ensures optimum performance.

5. OPERATION

0 765 99 unlocking

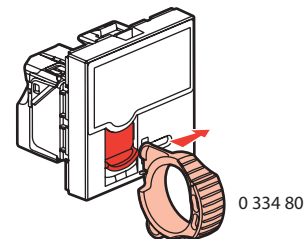

Installation

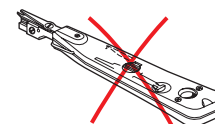
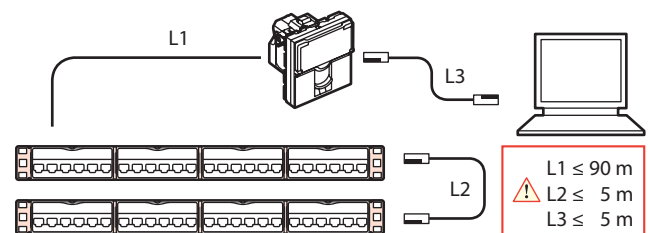

6. TECHNICAL CHARACTERISTICS

6.1 Mechanical characteristics

Impact resistance: IK 03
 IK 04 for 1 module
 Penetration against solid bodies and liquids: IP 20
 Max. number of connections and disconnections: 5 without refreshing the wiring.
 Endurance: 2500 movements (plug insertion/withdrawal).

6.2 Material characteristics

Contacts: Gold/nickel, minimum thickness of gold > 0.8 µm
 Metal parts: Bronze, nickel, platinum, gold
 For STP products the body and the spreader are made of metal alloy with a copper-nickel coating.

Base: Polycarbonate
 Cover plate: Polycarbonate with antimicrobial* treatment
 Halogen-free
 UV-resistant

Self-extinguishing:
 850°C/30 s for insulating components holding live parts in place
 650°C/30 s for other insulating components

6.3 Electrical characteristics

Breakdown voltage ≥ 1000 V
 Contact resistance ≤ 20 mΩ
 Insulation resistance ≥ 500 mΩ at 100 Vdc
 Tested and independently certified to comply with IEC 60512-99-001 and IEC 60512-99-002 for PoE support up to 90 W (Type 4).

6.4 Climate characteristics

Storage temperature: - 10°C to + 70°C
 Operating temperature: - 10°C to + 60°C

7. CLEANING

Clean the surface with a cloth.
 Do not use acetone, tar-removing cleaning agents or trichloroethylene.

7.1 Resistance to cleaning products

Resistant to the following products: hexane (NF C 61-314), methylated spirit, soapy water, diluted ammonia, bleach diluted to 10%, window-cleaning products, pre-impregnated wipes.

7.2 Resistance to hospital grade cleaning products

Resistant to the following products: Anios, Surfianios, Bactilyisine, diluted hydrogen peroxide (35%).

Caution: Always test before using other special cleaning products.

8. STANDARDS AND APPROVALS

ISO/IEC 11801 series : International standard for generic cabling for customer premises

ANSI/TIA 568 series : North American standard for generic cabling for customer premises

EN 50173 series : European standard for generic cabling for customer premises

IEC 60603-7 series : International standard for connector specifications
 Connectors are compliant to requirements for the following remote powering applications

IEEE 802.3af , IEEE 802.3at , IEEE 802.3bt : "Power over Ethernet", Types 1 to 4, up to 90 W.

9. PERFORMANCE

9.1 Performance of permanent link with F/UTP cable

Return loss

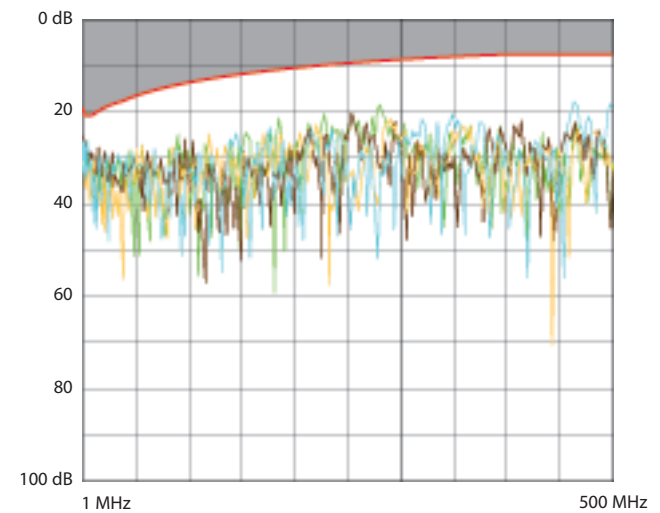

Attenuation

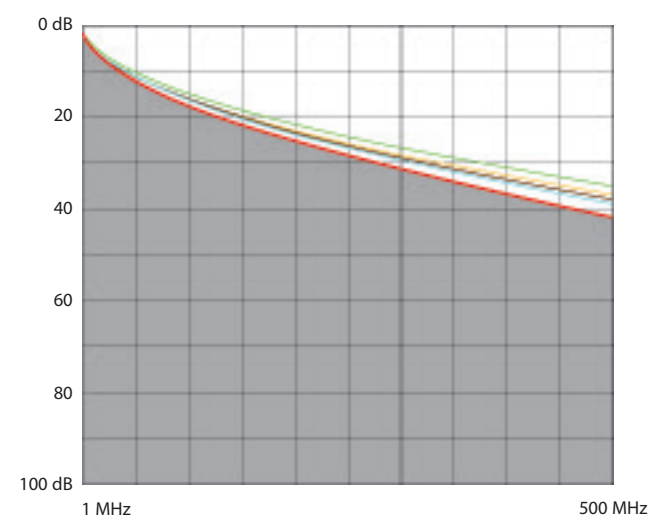

NEXT (Near end Crosstalk Attenuation)

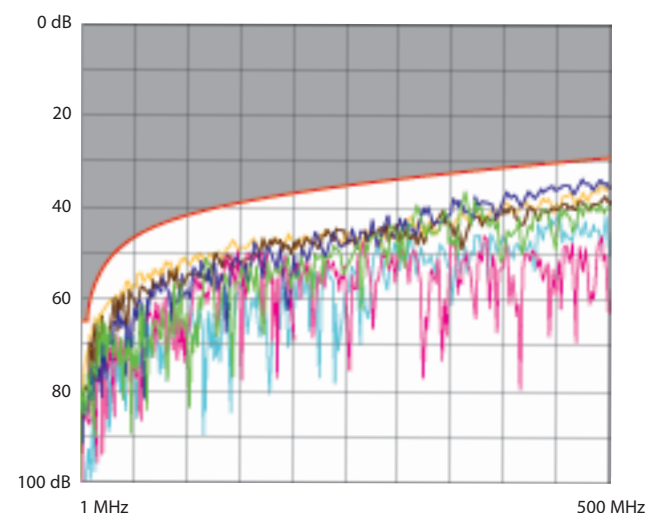

9. PERFORMANCE (cont.)

■ **9.1 Performance of permanent link with F/UTP cable (cont.)**
PS NEXT (Power Sum NEXT)

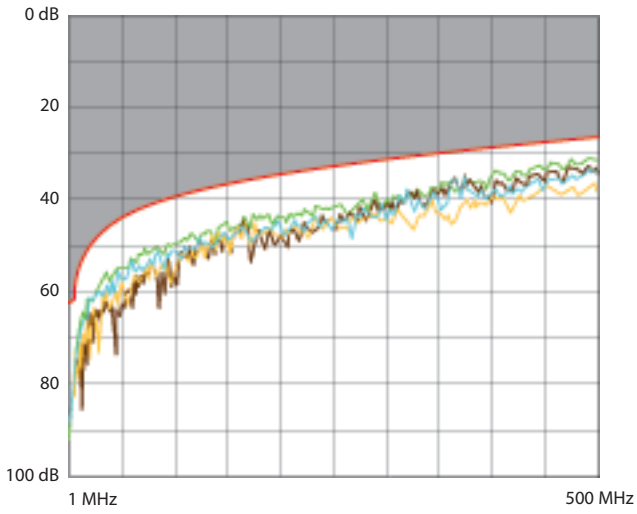

ACR (Attenuation to Crosstalk Ratio)

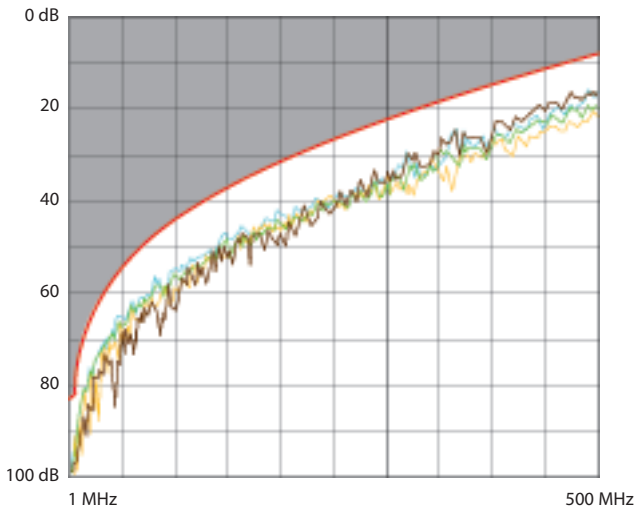

ELFEXT (Equal Level End Crosstalk Attenuation)

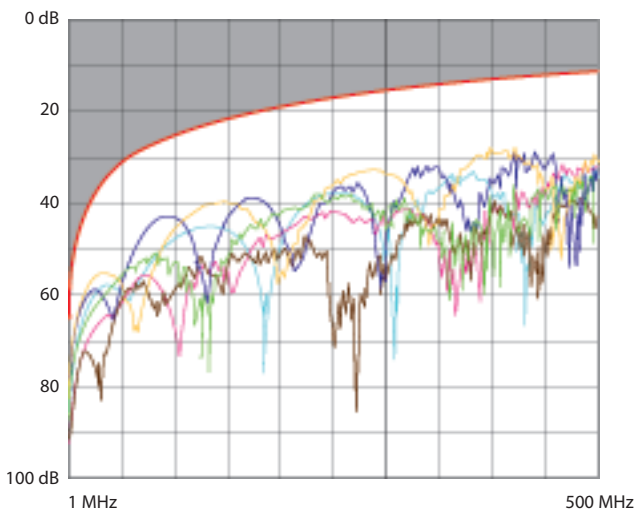

9. PERFORMANCE (cont.)

■ **9.1 Performance of permanent link with F/UTP cable (cont.)**
Delay skew

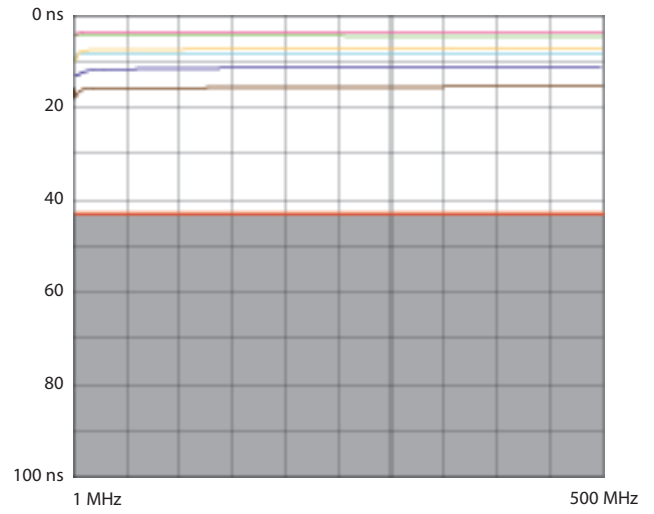

■ **9.2 Performance of permanent link with S/FTP cable**
Return loss

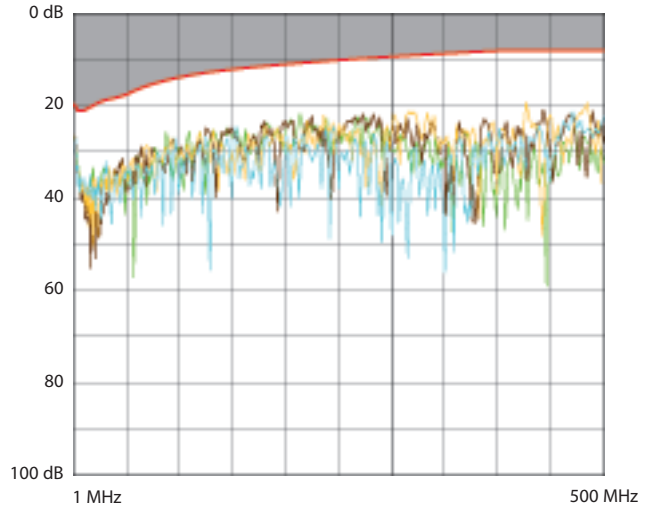

Attenuation

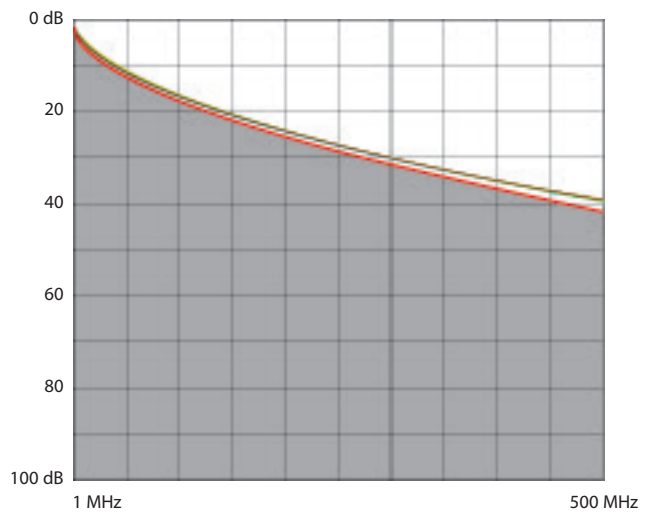

9. PERFORMANCE (cont.)

■ 9.2 Performance of permanent link with S/FTP cable (cont.)
NEXT (Near end Crosstalk Attenuation)

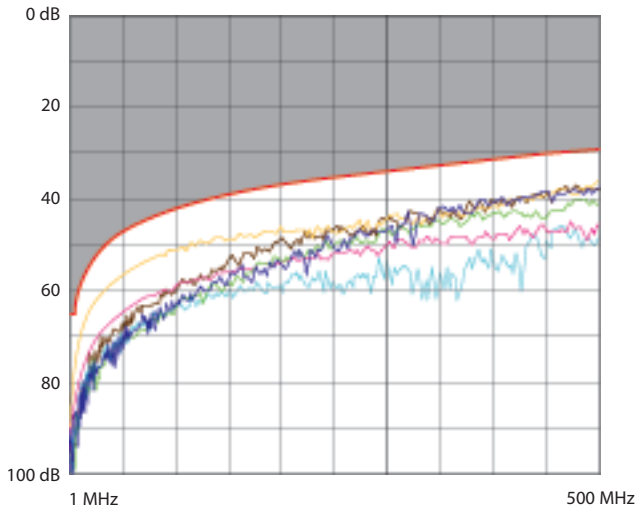

PS NEXT (Power Sum NEXT)

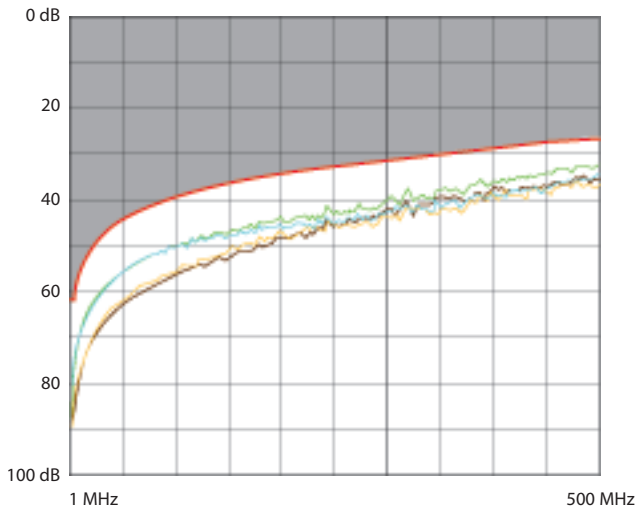

ACR (Attenuation to Crosstalk Ratio)

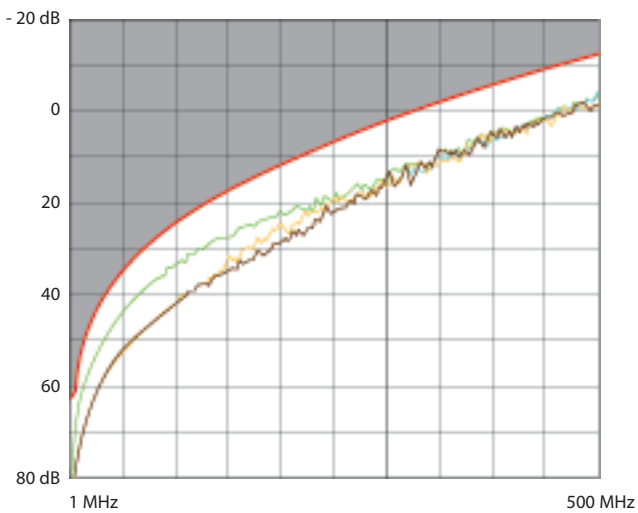

9. PERFORMANCE (cont.)

■ 9.2 Performance of permanent link with S/FTP cable (cont.)
ELFEXT (Equal Level End Crosstalk Attenuation)

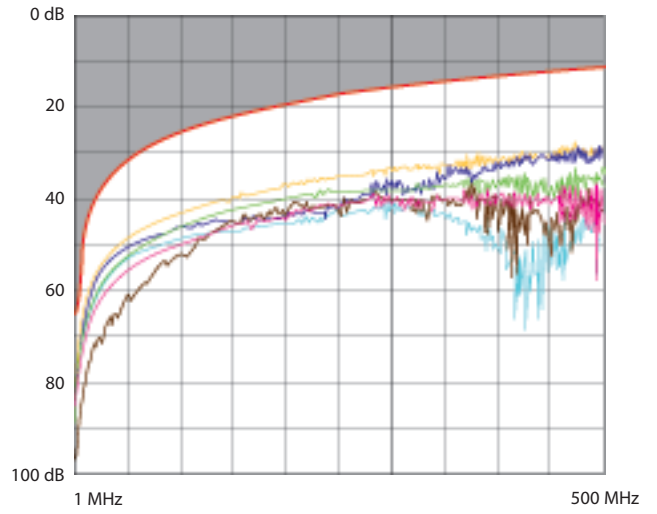

Delay skew

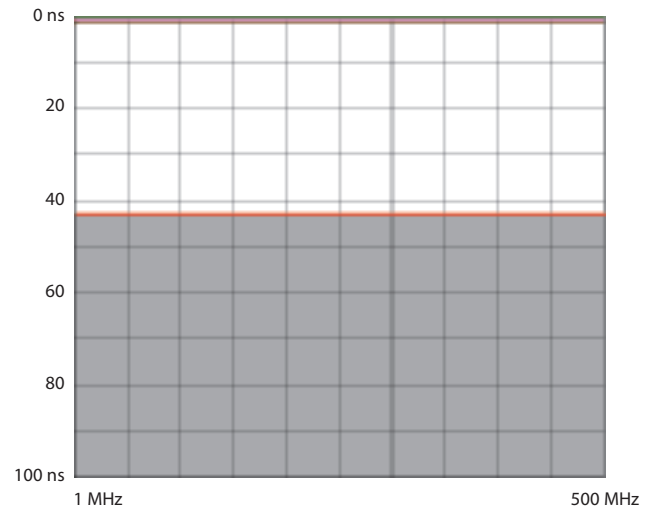

■ 9.3 Channel performance

Return loss

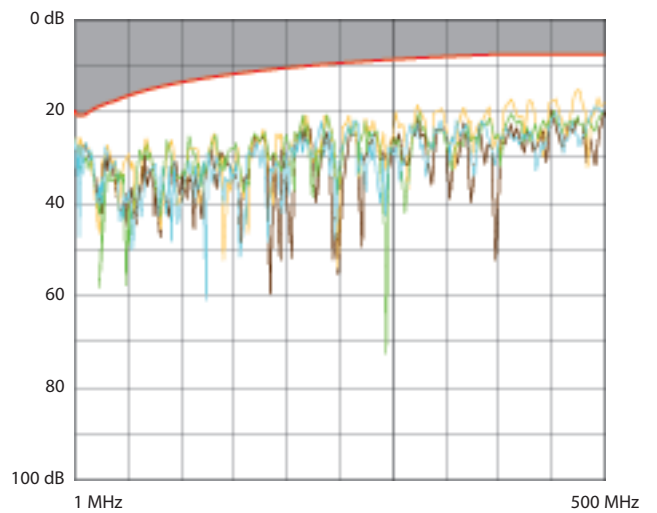

9. PERFORMANCE (cont.)

■ 9.3 Channel performance (cont.)

Attenuation

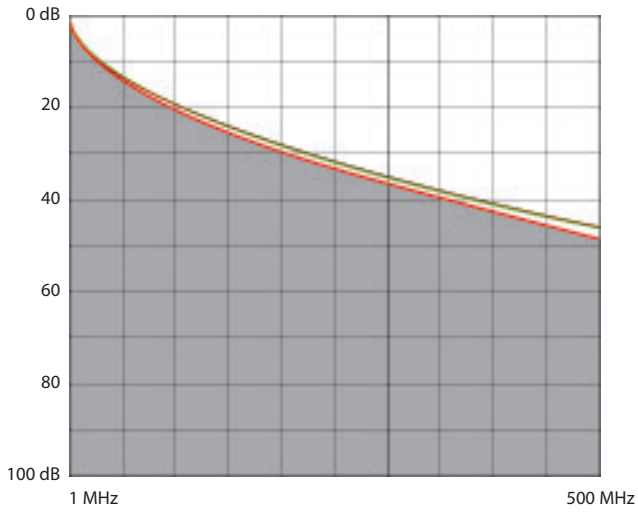

9. PERFORMANCE (cont.)

■ 9.3 Channel performance (cont.)

ACR (Attenuation to Crosstalk Ratio)

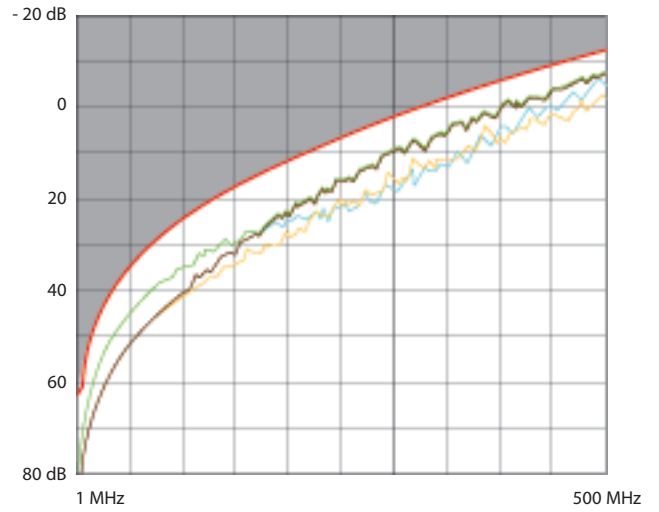

NEXT (Near end Crosstalk Attenuation)

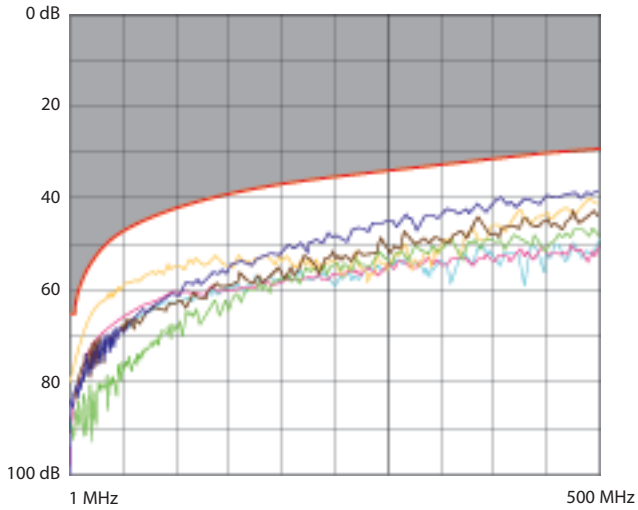

ELFEXT (Equal Level End Crosstalk Attenuation)

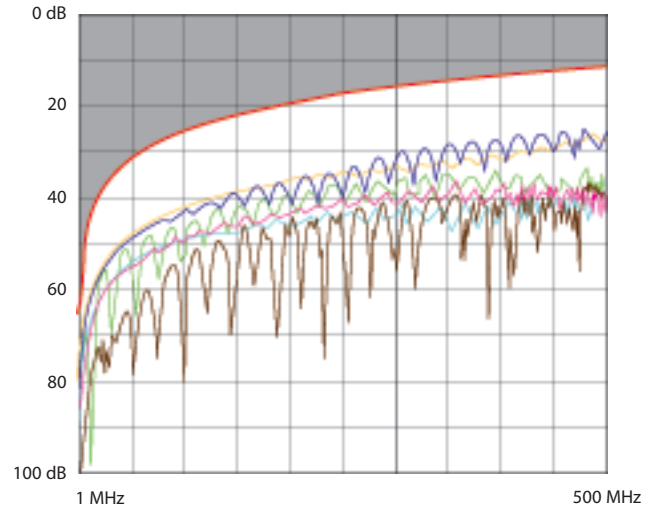

PS NEXT (Power sum NEXT)

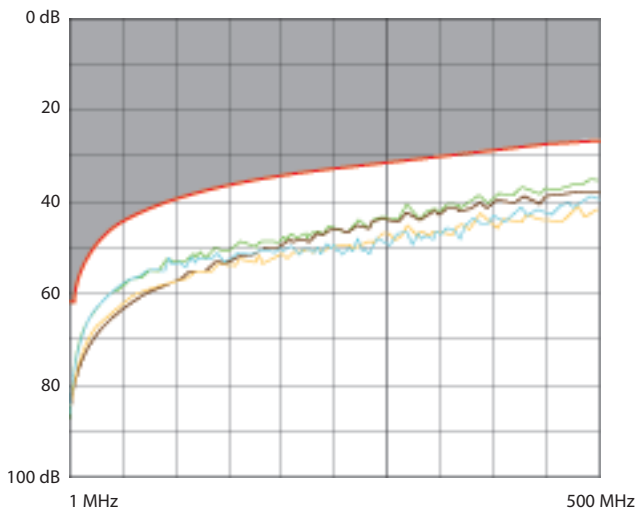

Delay skew

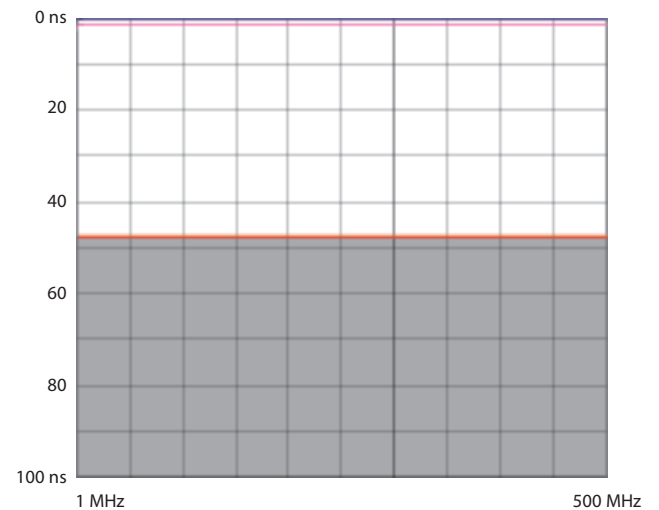

* Contains a silver compound to ontagonize the growth of bacteria on the surface.