

A	B
130 x 130	
155 x 110	
180 x 140	
220 x 170	
270 x 170	
310 x 240	✗
360 x 270	✗

1

2

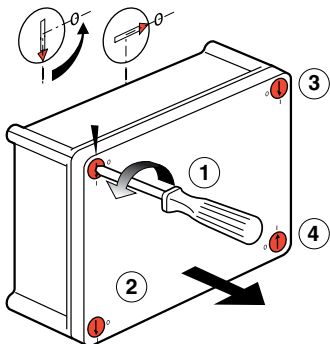
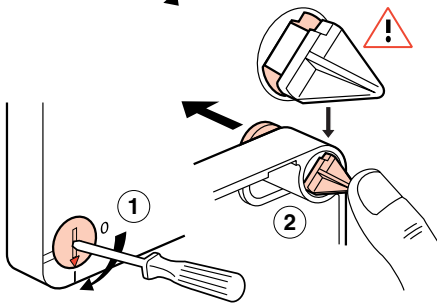
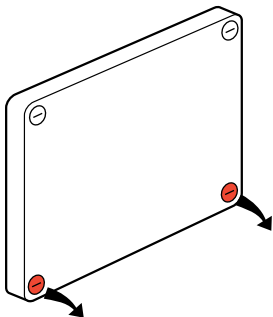

3

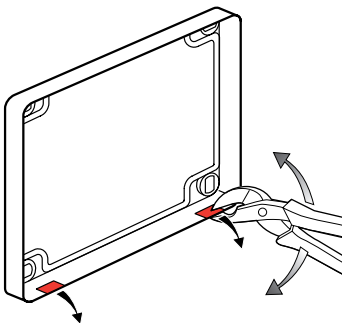

4

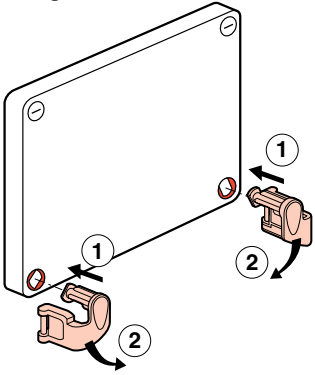
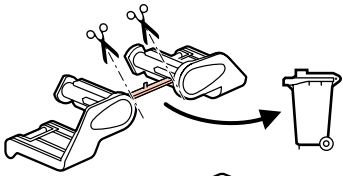

5

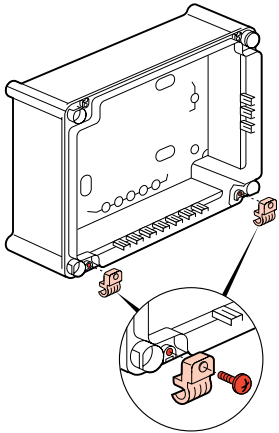

6

