

RCD add-on module DX³ with metering/measuring unit

Cat.Nos: 4 106 57 to 4 106 59

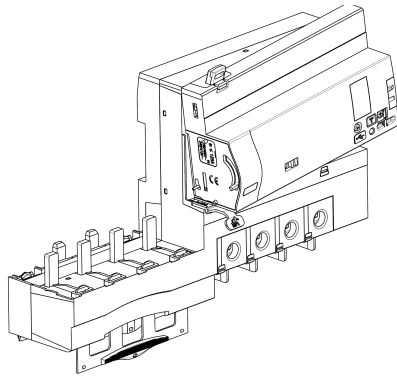

CONTENTS	PAGE
1. Description - Use.....	1
2. Range	1
3. Overall dimensions.....	2
4. Fixing – Connection.....	3
5. General characteristics.....	4
6. Compliance and approvals.....	9
7. Curves	10
8. Auxiliaries and accessories	11

1. DESCRIPTION - USE

RCD add-on modules with metering/measuring unit for MCBs. DX³, 1,5 modules per pole width, breaking capacity 10000A/16kA, 25kA, 36kA or 50kA.

They protect people against direct and indirect electric shocks and installations against insulation faults. They enable, in addition, the measurement of the main electrical quantities (depending on the version: voltage, current, residual current, power, energy, frequency, power factor, THD, the historical of causes of recent trips).

Symbol:

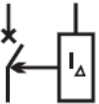

Technology:

. Electronic residual current operating.

2. RANGE

Number of poles:

. 4 poles.

Width:

. Four poles – 7,5 modules (7,5 x 17,8 mm = 133,5 mm).

Rated Currents, In:

. In 63A (cat. no 4 106 57):

. In 125 A (cat. nos 4 106 58 / 59) :

Features:

. Basic functions common to all devices:
Remote report of the data

2. RANGE (continued)

Features (continued)

. Specific functions of the add-on module with metering unit (cat. N° 4 106 57 / 58):

Currents L1 L2 L3 N (in A)
Residual current (in mA or A)
Instantaneous total active power L1 L2 L3 (in W or kW)
Total energy consumption (in kWh)

. Specific functions of the add-on module with measuring unit (cat. N° 4 106 59):

Currents L1 L2 L3 N (in A)
Residual current (in mA or A)
Voltages
Powers
Energies
Frequency
THD
Power factor (cos φ)
Cause of last trip

Type:

. A-Hpi: sinusoidal AC fault currents with or without DC component and immunity against unwanted tripping (Hpi type are also A types).

Sensitivities and Tripping time:

. Adjustable sensitivity: 30mA, 300ma, 1A or 3A with instantaneous or delayed tripping of 300ms, 1s or 3s.
If IΔn is set to 30mA, instantaneous trip only.

Rated Voltage / Frequency:

. 230 / 400 V~, 50 Hz standard tolerances.
. 240 / 415 V~, 50 Hz standard tolerances.

Maximum operating voltage:

. 415 V~ + 10%, 50 Hz with standard tolerances.

Minimum operating voltage:

. 185 V~, 50 Hz.

RCD add-on module DX³ with integrated measure

Cat.Nos: 4 106 57 to 4 106 59

2. RANGE (continued)

Compatibility with MCBs DX³:

	Breaking Capacity	Curve	4 106 57	4 106 58	4 106 59
DX ³	10000A / 16kA	B, C, D	--	$80A \leq I_n \leq 125A$	$80A \leq I_n \leq 125A$
	25kA	B, C, Z	$32A \leq I_n \leq 63A$	$32A \leq I_n \leq 125A$	$32A \leq I_n \leq 125A$
	25kA	D, MA	$12,5A \leq I_n \leq 63A$	$12,5A \leq I_n \leq 125A$	$12,5A \leq I_n \leq 125A$
	36kA	C	$10A \leq I_n \leq 63A$	$10A \leq I_n \leq 80A$	$10A \leq I_n \leq 80A$
	50kA	B, C, D, MA	$10A \leq I_n \leq 63A$	$10A \leq I_n \leq 63A$	$10A \leq I_n \leq 63A$

3. OVERALL DIMENSIONS

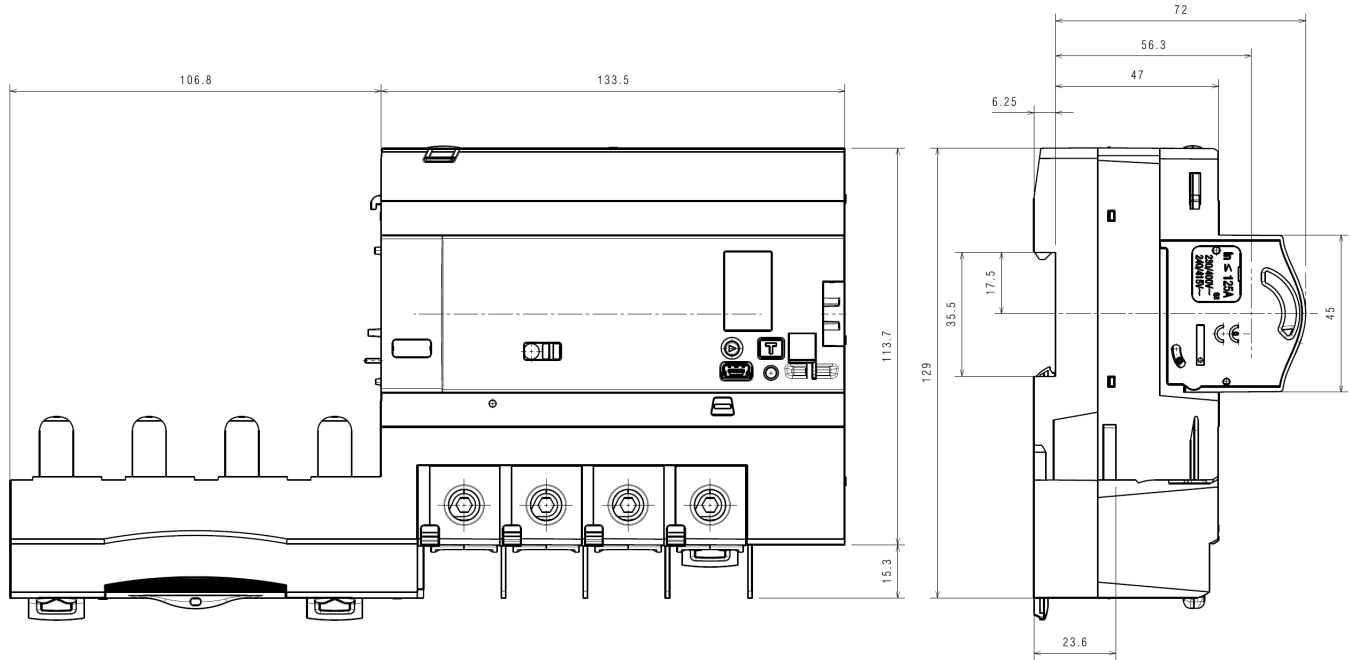

RCD add-on module DX³ with integrated measure

Cat.Nos: 4 106 57 to 4 106 59

4. FIXING - CONNECTION

Assembling:

. On the right side of the MCBs. DX³, 1.5 modules per pole width, breaking capacity 10000A/16kA, 25kA, 36kA or 50kA.. Associated to the circuit breaker by plastic clamps and tightening of connections in the downstream terminals of the MCB.

Mounting:

. On symmetrical EN/IEC 60715 rail or DIN 35 rail.

Power supply:

. From the top trough the associated MCB or from the bottom directly on the add-on module.

Operating position:

. Vertical Horizontal Upside down On the side

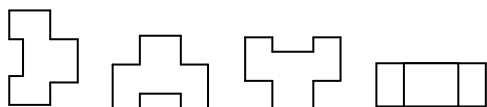

Screw terminals:

. Terminals protected against accidental contact (IP20).
 . The screw terminals are separated by built-in shields.
 . Cage terminals, with release and captive screw

. Add-on module In 63A:

Terminal depth: 19 mm.

Stripping length : 17 mm

Screw head: mixed, slotted and Pozidriv n°2.

Recommended tightening torque: 3 Nm.

Min. and maxi tightening torque: 2,5Nm and 4,5 Nm.

. Add-on module In 125A:

Terminal depth: 19 mm.

Stripping length : 17 mm

Screw head: Allen screw 4 mm.

Recommended tightening torque: 5,5 Nm.

Min. and maxi tightening torque: 4,5Nm and 10 Nm.

Connectable section:

. In the power terminals in the lower part of the product.

. Copper cable.

. Add-on module In 63A

	Without ferrule	With ferrule
Rigid cable	1,5 to 50 mm²	-
Flexible cable	1,5 to 35 mm²	1,5 to 35 mm²

. Add-on module In 125A

	Without ferrule	With ferrule
Rigid cable	6 to 70 mm²	-
Flexible cable	6 to 50 mm²	6 to 50 mm²

. In the automatic terminals in the lower part of the product.

. Copper cable.

	Without ferrule	With ferrule
Rigid cable	0,75 to 2,5 mm²	-
Flexible cable	0,75 to 2,5 mm²	0,75 to 1,5 mm²

4. PREPARATION – CONNECTION (continued)

Tools required:

. For the terminals: Pozidriv n°3 or flat screwdriver 6 mm (6,5 mm maximum).

. For fixing: flat screwdriver 5,5 mm (6 mm maximum).

Tools required:

. For the Allen terminals: Allen wrench 4 mm.

. For the Pozidriv terminals: Pozidriv n°2 or flat screwdriver 5,5 mm (6,5 mm maximum)

. For fixing on the DIN rail: flat screwdriver 5.5 mm (from 4 to 6 mm).

Manual actuation of the add-on module:

. By the 2-positions ergonomic handle of the associated MCB.

- I / ON : Closed circuit.

- O / OFF : Open circuit.

Contacts status display:

. By marking of the associated MCB. handle:

“O-Off” white on a green background = contacts opened.

“I-On” white on a red background = contacts closed.

Report of the contacts position:

. The MCB contacts position is available through the communication.

Possible positions : Closed / Open / Manual or on short-circuit trip / trip caused by a residual current fault

Display of fault trip caused by a residual current:

. Yellow mechanical signaller into the window on front-side marking zone.

Signalling the state of the device:

. Signalling by bi colour LED:

- Green fixed: normal operation.

- Green flashing: settings in progress.

- Red fixed: value of the residual current (I_Δ) exceeds 45% of the set value.

- Red flashing: value of the residual current (I_Δ) exceeds 60% of the set value.

- Red / Green alternate flashing: Self-protection due to overheating.

Labelling:

. Circuit identification by insertion of a label in the label holder of the associated MCB.

Battery type:

. Lithium CR1616. Qty:2

Battery voltage:

. 3 V d.c.

Battery current:

. 50 mAh.

RCD add-on module DX³ with integrated measure

Cat.Nos: 4 106 57 to 4 106 59

5. GENERAL CHARACTERISTICS

Front face marking:

. By permanent ink pad printing.

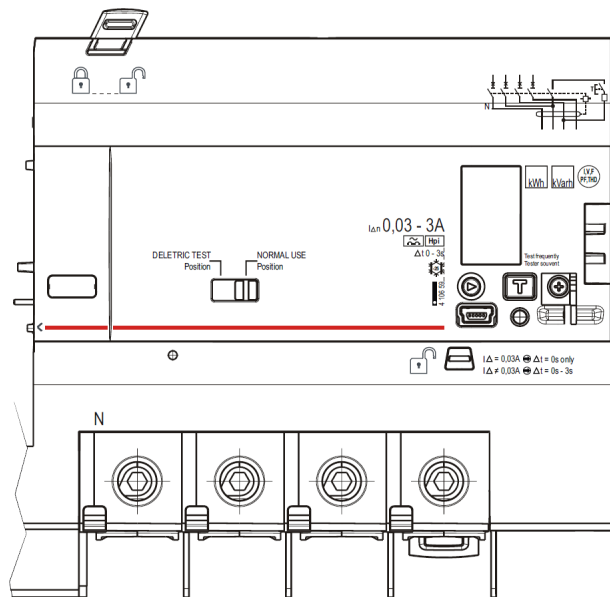

Right-side marking:

. By permanent ink pad printing with the indication for assembly and disassembly of the MCB and of the add-on module

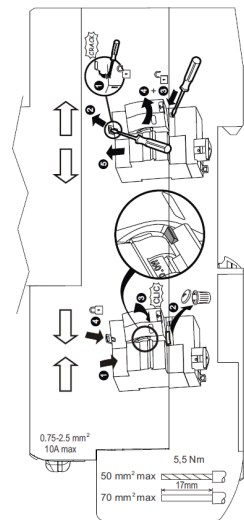

"Test" key operating voltages:

U min	170 V ~
U max	456.5 V ~

This voltage range enables to use double-pole add on modules in 230 V or 400 V, and triple / four poles add-on modules in network with or without neutral 230 V and 400 V. For the wiring of a four-poles add-on module in a three phase network without neutral, make sure to properly wire three consecutive poles to supply the test key.

Residual breaking capacity I Δ m:

. In accordance with standard EN 60947-2 (I Δ m: short-circuit to ground)

I Δ m = 60% of I_{cu} of the associated MCB.

5. GENERAL CHARACTERISTICS (continued)

Neutral system:

. IT – TT – TN.

Insulation rated voltage:

. U_i = 500 V according to IEC/EN 60947-2

Pollution degree:

. 3.

Dielectric strength:

. 2500 V (for 1 min) according to EN/IEC 61439-1.

Pulse rated voltage:

. U_{imp} = 6 kV (wave 1.5 / 50 μ s).

Operation at different frequencies respect to the nominal frequency:

. The only operating frequency is the nominal frequency.

Protection against unwanted tripping:

- . Add-on module Hpi type, sensitivity set to 30mA:
held to the wave 8 / 20 μ s : 3000 A.
damped recurrent wave 0,5 μ s / 100 kHz : 200 A.
- . Add-on module Hpi type, sensitivity set to 300mA and more:
held to the wave 8 / 20 μ s : 5000 A.
damped recurrent wave 0,5 μ s / 100 kHz : 200 A.

Protection class:

- . Protection index of terminals against solid and liquid bodies (wired device): IP 20 (in accordance with standards IEC/EN 60529 and NF C 20-010).
- . Protection index of the front face against direct contacts: IP 40 (in accordance with standards IEC/EN 60529 and NF C 20-010).
- . Class II compared to conductive parts.
- . Protection index against mechanical shocks: IK 04 (accordance with standards IEC / EN 62262 et NF C 20-015).

Mechanical and electrical endurance (associated to a MCB)

- . 20000 operations without load
- . 10000 operations with load (under I_n x Cos φ =0.9)
- . 1000 tripping operations by the Test key.
- . 1000 tripping operations for fault residual current.

Power loss and impedance per device at In:

I _n (A)	Z(m Ω)	P(W)
6	1,94	0,07
10	1,90	0,19
16	1,95	0,5
20	1,95	0,78
25	1,92	1,2
32	1,95	2,0
40	0,55	0,88
50	0,55	1,37
63	0,55	2,17

RCD add-on module DX³ with integrated measure

Cat.Nos: 4 106 57 to 4 106 59

5. GENERAL CHARACTERISTICS (continued)

Power loss and impedance per device at I_n:

I _n (A)	Z(mΩ)	P(W)
80	0,24	1,6
100	0,24	2,4
125	0,24	3,8

Please note that to get the total power loss by the RCBO these powers must be added to those of the associated MCB.

Consumption:

. Max. 1 VA.

Plastics:

. Polycarbonate parts.

Resistance to abnormal heat and to fire:

. Fire retardant and self-extinguishing materials.
. Heat and fire resistant according to EN 61009, glow-wire test at 960°C for external parts made of insulating material necessary to retain in position current-carrying parts and parts of protective circuit (650°C for all other external parts made of insulating material).

Volume and quantity when packed:

. Four poles 4,6 dm³ per device.

Average weight per device:

. Four poles 1 kg.

Ambient operating temperature:

. Min. = -25°C. Max. = +60°C

Derating according ambient temperature:

. Reference temperature: 40 °C in accordance with standard IEC/EN 60947-2.

. No derating of the add-on module depending on the ambient temperature between - 25 ° C and +40 ° C.

. Derating between + 40 ° C to + 76 ° C :

Temperature	40 °C	50 °C	60 °C
% of I _n	100 %	95 %	90 %

Ambient storage temperature:

. Min. = -40°C. Max. = +70°C

Resistance to sinusoidal vibrations:

. According to IEC 60068-2-35.
. Axis : x, y, z.
. Frequency range: 5÷100 Hz ; duration 90 minutes
. Displacement (5÷13,2 Hz) : 1mm.
. Acceleration (13,2÷100 Hz) : 0,7g (g=9,81 m/s²)

5. GENERAL CHARACTERISTICS (continued)

Influence of the altitude :

	2000 m	3000 m	4000 m	5000 m
Dielectric strength	3000 V	2500 V	2000 V	1500 V
Max operating voltage	400 V	400 V	400 V	400 V
Derating at 40°C	none	none	none	none

Measured quantities and measurement accuracy class:

. Currents (accuracy class 1) :

phase: I₁, I₂, I₃ ;

neutral: I_N.

. Voltage (accuracy class 0,5) :

phase/phase: U₁₂, U₂₃, U₃₁ ;

phase/neutral: V_{1N}, V_{2N}, V_{3N}.

. Frequency (accuracy 0,1%)

. Power:

instantaneous total active power;

instantaneous total reactive power.

. Power factor (cos φ).

. Energy :

total active energy, positive and negative (accuracy class 1);

total reactive energy, positive and negative (accuracy class 2).

. THD :

THD of Voltages: V₁, V₂, V₃;

THD of currents: I₁, I₂, I₃, I_N.

Historical:

. Historical of causes of recent trips :

trip due to residual current fault (value of the residual current)

overheating (temperature value)

trip by test key

RCD add-on module DX³ with integrated measure

Cat.Nos: 4 106 57 to 4 106 59

5. GENERAL CHARACTERISTICS (continued)

Display card:

. The display is the user interface. It consist of:

1. Backlight LCD display;
2. Navigation key;
3. USB Port;
4. RCD Test key;
5. Bi-colour LED;
6. Setting key;
7. Battery compartment

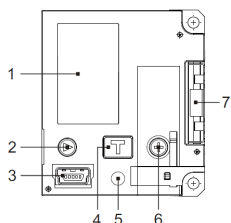

Programming pages:

. The settings are implemented by pressing the key .
 . The adjustable parameters are the values of the residual current and the tripping time:

. Rated residual current (possible settings 30mA, 300mA, 1A, 3A):

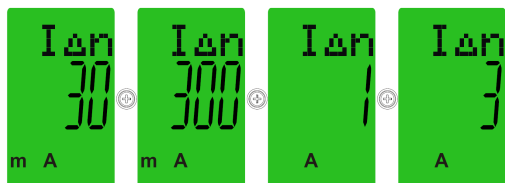

. Tripping time (possible settings 0s, 300ms, 1s, 3s) :

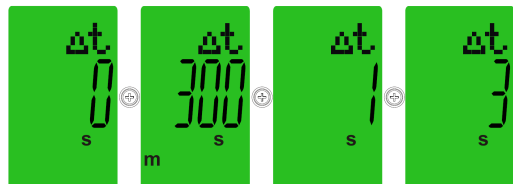

Display pages:

. The display of the pages is realised via the navigation button ;
 (According to the version "metering unit" or "measuring unit" some pages are not available).

. Display of set parameters:

Rated residual current (set value)

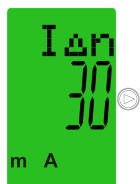

Tripping time (set value)

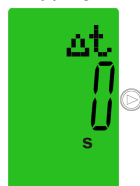

5. GENERAL CHARACTERISTICS (continued)

Display pages - Measured quantities:

. Display of measured quantities:

. Current (phases / neutral / residual current)

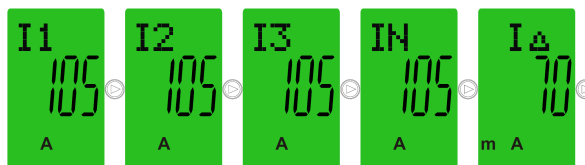

. Phase Voltages

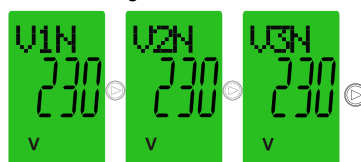

. Power (active and reactive) and Power Factor



Frequency



Active energy (positive and negative)

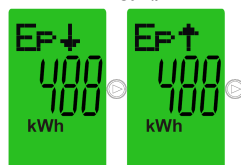

Reactive energy (positive and negative)

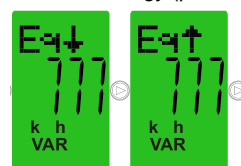

THD of the Phase Voltages

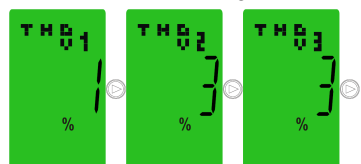

THD of Currents (phase and neutral)

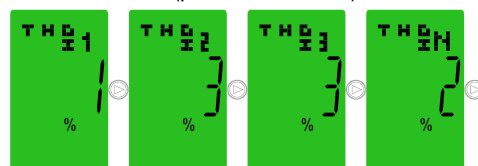

5. GENERAL CHARACTERISTICS *(continued)*

Display pages - Measured quantities *(continued)*:

- . Historical of causes of recent trips :
 - no tripping
 - trip due to residual current fault (value of the residual current)
 - trip by test key
 - overheating (temperature value)

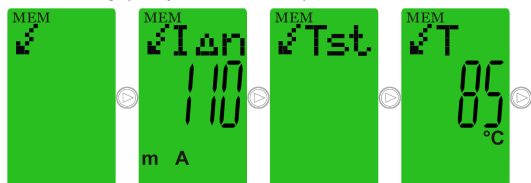

- . Exhausted batteries (the symbol  appears on all pages):

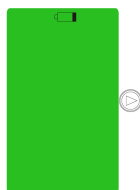

Integration of the add-on module in the remote display and monitoring system:

- . The communication port is located on the lower side of the device.

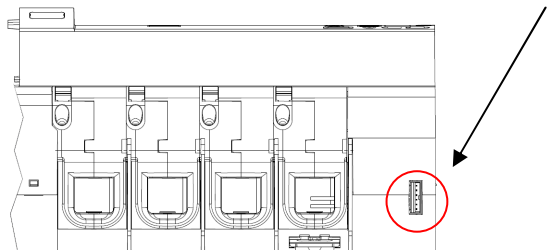

The port enables the integration of the device in the monitoring system via the RS485 communication interface (ref 4 210 75) and the Gateway RS485/IP.

Wiring diagram:

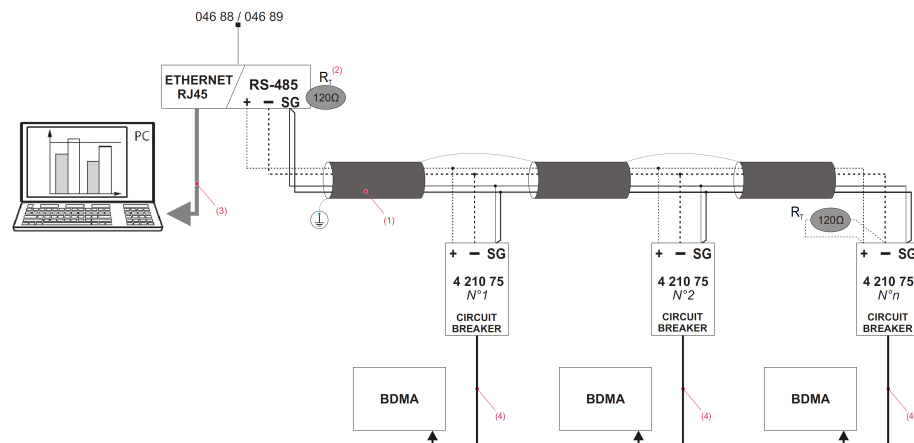

- (1)RS485:
Prescribed use of Cable Belden 9842 (or equivalent) for a maximum bus length of 1000m or category 6 Cable (FTP or UTP) for a maximum length of 50m;
- (2)Termination Resistor RT integrated.
- (3)Ethernet:
Category 6 Cable (FTP or UTP).
- (4)Cable supplied with the module 4 210 75.

RCD add-on module DX³ with integrated measure

Cat.Nos: 4 106 57 to 4 106 59

6. COMPLIANCE AND APPROVALS

Compliance to standards:

- . IEC 60947-2.
- . IEC 60051
- . IEC 61557-12.
- . IEC 62053

Environment respect – Compliance with CEE directives:

- . Compliance with Directive 2002/95/EC of 27.1.2003 called "RoHS" provides the banishment of hazardous substances such as lead, mercury, cadmium, hexavalent chromium, brominated flame retardants polybrominated biphenyls (PBB) and polybrominated diphenylethers (PBDE) from 1 July 2006
- . Compliance with Directives 91/338/CEE of 18/06/91 and decree 94-647 of 27/07/04.
- . Compliance with Directives 73/23/CEE and 93/68/CEE (DBT).
- . Compliance with Directives 83/336/CEE, 92/31/CEE and 93/68/CEE (CEM).

Plastic materials :

- . Halogen-free plastic materials.
- . Marking of parts according to ISO 11469 and ISO 1043.

Packaging:

- . Design and manufacture of packaging in accordance with decree 98-638 of 20.07.1998 and Directive 94/62/EC.

Compliance with IEC 61557-12 Edition 1 (08/2007)

PMD Characteristics		
Type of characteristic	Specification values	Other complementary characteristics
Power quality assessment function	-	-
Classification of PMD	DD	-
Temperature	K55	-
Humidity + Altitude	Conditions standards	-
Active power or active energy function performance class	1	-

RCD add-on module DX³ with integrated measure

Cat.Nos: 4 106 57 to 4 106 59

6. COMPLIANCE AND APPROVALS (continued)

Compliance with IEC 61557-12 Edition 1 (08/2007)

Symbol for functions	Measurement range	Function performance class according to IEC 61557-12	Other complementary characteristics
	63 A 125 A		63 A 125 A
P	0,0125...75 kW 0,025...150 kW	1	I _b =20 A, I _{max} =75 A I _b =40 A, I _{max} =150 A UN=400 V, f _N =50 Hz
Q _A , Q _V	0,0125...75 kvar 0,025...150 kvar	1	I _b =20 A, I _{max} =75 A I _b =40 A, I _{max} =150 A UN=400 V, f _N =50 Hz
S _A , S _V	-	-	-
E _a	0...9999 MWh	1	I _b =20 A, I _{max} =75 A I _b =40 A, I _{max} =150 A UN=400 V, f _N =50 Hz
E _{rA} , E _{rV}	0...9999 Mvarh	1	I _b =20 A, I _{max} =75 A I _b =40 A, I _{max} =150 A UN=400 V, f _N =50 Hz
E _{apA} , E _{apV}	-	-	-
f	45...65 Hz	0.1	-
I	1,25...75 A 2,5...150 A	1	I _b =20 A, I _{max} =75 A I _b =40 A, I _{max} =150 A UN=400 V, f _N =50 Hz
I _N , I _{Nc}	1,25...75 A 2,5...150 A	1	I _b =20 A, I _{max} =75 A I _b =40 A, I _{max} =150 A UN=400 V, f _N =50 Hz
U	88...550 V	0.5	-
P _{FA} , P _{FV}	-	1	I _b =20 A, I _{max} =75 A I _b =40 A, I _{max} =150 A UN=400 V, f _N =50 Hz
P _{st} , P _{It}	-	-	-
U _{dip}	-	-	-
U _{swt}	-	-	-
U _{tr}	-	-	-
U _{int}	-	-	-
U _{nba}	-	-	-
U _{nb}	-	-	-
U _h	-	-	-
THD _u	-	-	-
THD-R _u	88...550 V	0.5	-
I _h	-	-	-
THD _i	1,25...75 A 2,5...150 A	1	I _b =20 A, I _{max} =75 A I _b =40 A, I _{max} =150 A
THD-R _i	-	-	-
Msv	-	-	-

7. CURVES

Residual current operating characteristic

. Average tripping time depending on the intensity of the fault current.
 . Sensitivities 30mA, 300mA, 1000mA and 3000mA instantaneous (Hpi types)

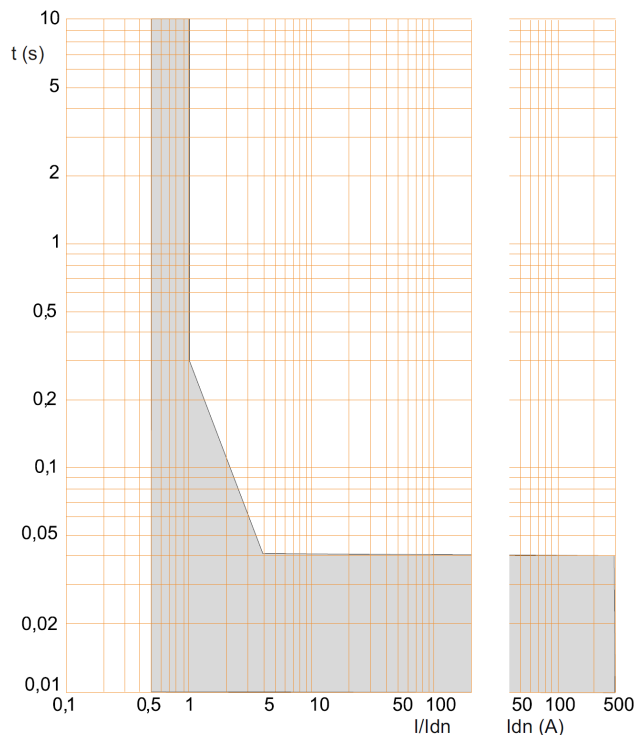

Residual current operating characteristic

. Sensitivities 300mA, 1000mA and 3000mA Hpi type with a time delay of 300ms.

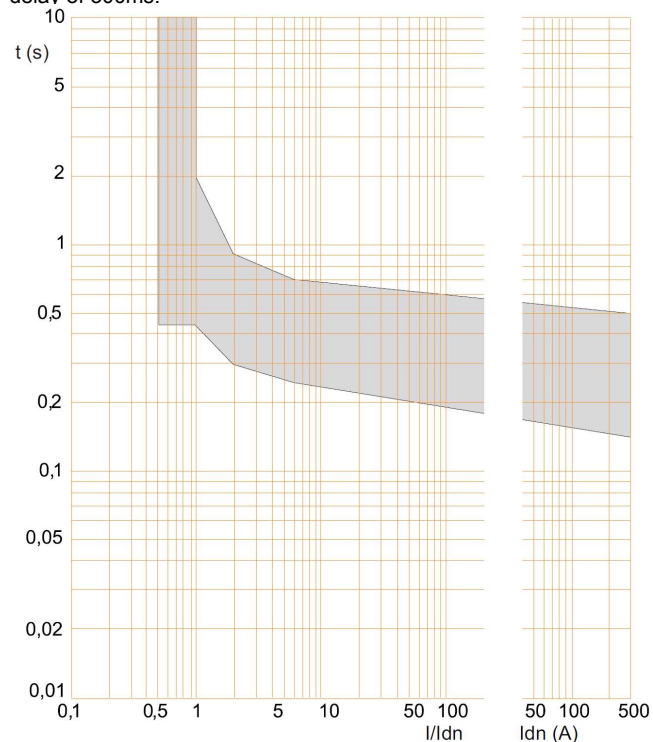

7. CURVES (continued)

Residual current operating characteristic

. Sensitivities 300mA, 1000mA and 3000mA Hpi type with a time delay of 1s.

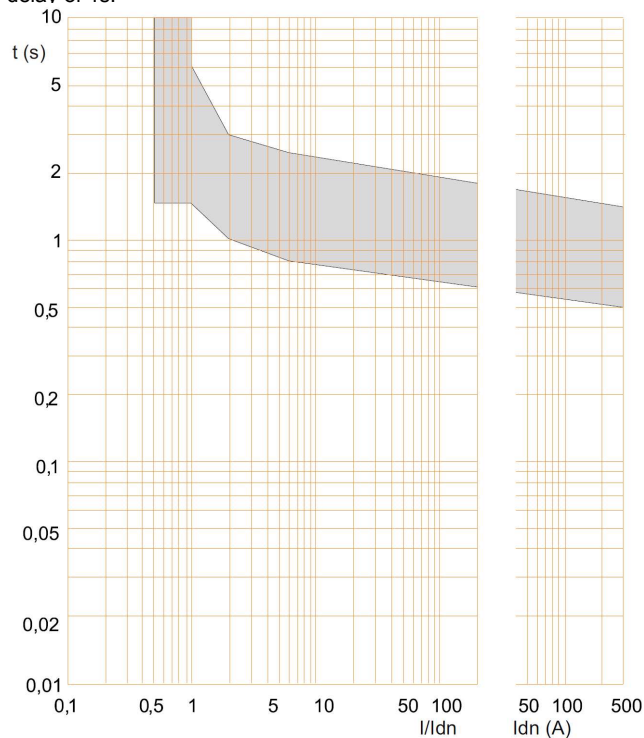

Residual current operating characteristic

. Sensitivities 300mA, 1000mA and 3000mA Hpi type with a time delay of 3s.

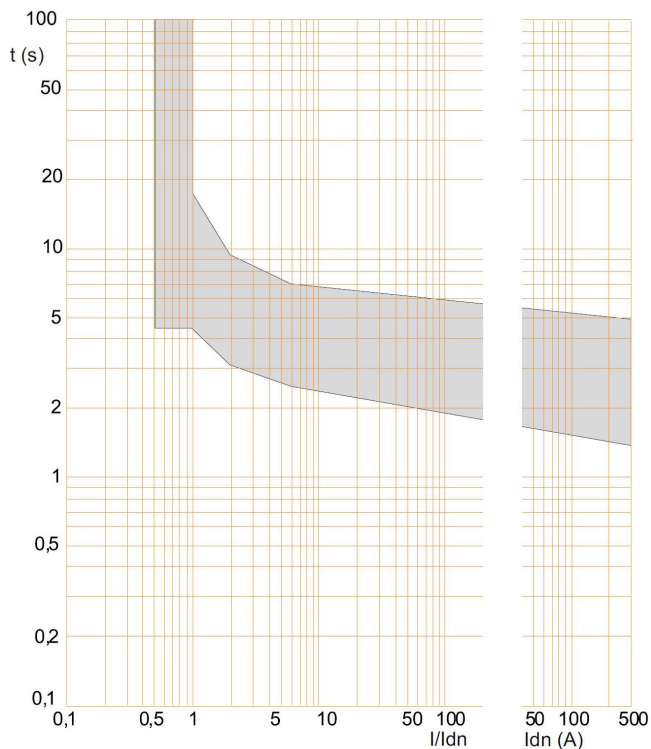

8. AUXILIARIES AND ACCESSORIES

Installation software:

. XL Pro³.