

Eco-dimmer

Catalogue number(s): **0 670 83 - 0 488 69/70/71**
0 784 07 - 0 792 07 - 6 651 14 - 5 722 39 - 5 727 39 - 5 743 19/39

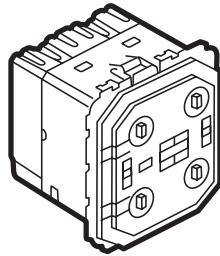

CONTENTS

Page





1. Use	1
2. Range	1
3. Dimensions (mm)	1
4. Connection	2
5. Wiring	2
6. Operation	2
7. Technical features	3
8. Maintenance	3
9. Standards and approvals	3

1. USE

Comfort with dimming:
 ECO 2-wire any bulb eco-dimmer

- Dimmable LED
- Dimmable compact fluorescent
- Fluorescent
- Halogen

2. RANGE

	Description	Catalogue Nos.
	Céliane eco-dimmer	0 670 83
	Complete ready-to-install kit Céliane Titanium eco-dimmer	0 488 69
	Niloé eco-dimmer	6 651 14
	Ready-to-install kit Niloé eco-dimmer	0 488 71
	Mosaic eco-dimmer - White	0 784 07
	Ready-to-install kit Mosaic eco-dimmer - White	0 488 70
	Mosaic eco-dimmer - Aluminium	0 792 07
	Arteur square eco-dimmer - White	5 722 39
	Arteur square eco-dimmer - Aluminium	5 727 39
	Arteur round eco-dimmer - White	5 743 19
	Arteur round eco-dimmer - Aluminium	5 743 39

3. DIMENSIONS (mm)

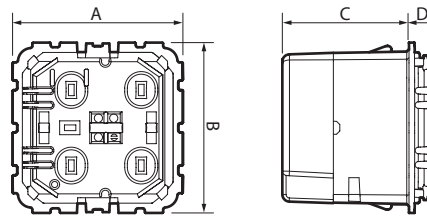

Catalogue Nos.	A	B	C	D
0 670 83	45	45	33.5	7.2
0 784 07 - 0 792 07	45	45	33.5	9.6
5 722 39 - 5 727 39	45	45	33.5	9.6
5 743 19 - 5 743 39				

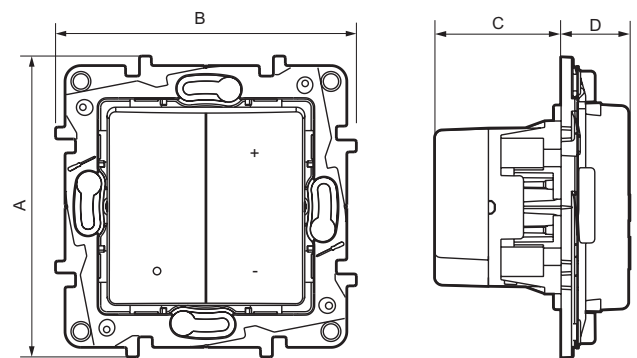

Catalogue Number	A	B	C	D
6 651 14	80	80	30	20

4. CONNECTION

Screw terminals
Terminal capacity: 2 x 2.5 mm²
Stripping length: 8 mm

5. WIRING

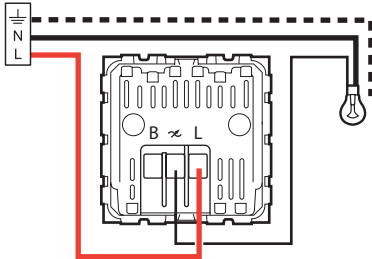

Wiring with Céliane pushbutton

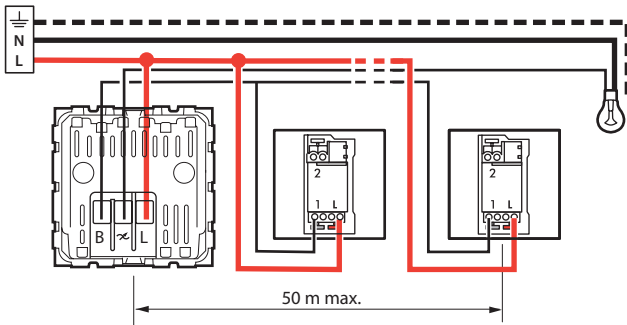
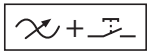

Wiring with Niloé pushbutton

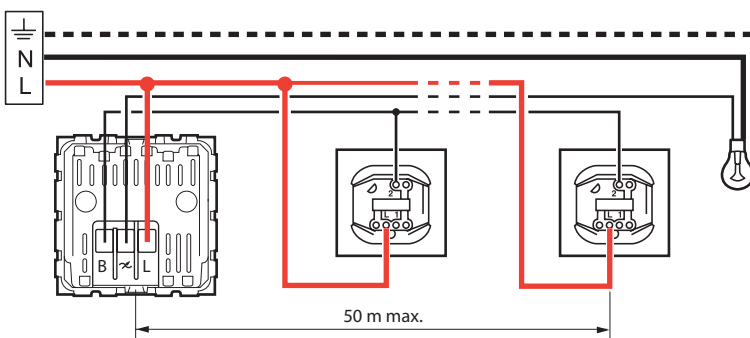
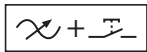

6. OPERATION

In order to start up the different usage types, unclip the rocker plates and press the buttons shown in the panel for 2 seconds. Video animations available at www.legrandoc.com

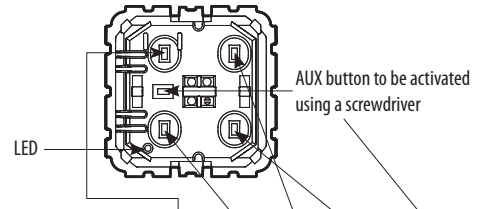

Usage types	ON	OFF	+	-	AUX
Restore to factory configuration (load recognition, capacitive mode, pushbutton assembly, level memory)	X	X	X	X	
Level memory activation	X	X	X		
Level memory deactivation	X	X		X	
Forced capacitive mode (no load recognition)	X	X		X	X
Forced inductive mode (no load recognition)	X	X	X		X
Children's bedrooms (pre-set levels + night light)	X	X			X
Pre-set levels mode			X	X	X
Dimmer mode		X	X		X

If the device is handled incorrectly: press the ON and OFF buttons only, the dimmer will not work using the pushbutton. You must then press the + and - buttons in order to operate with the pushbutton again.

















The LED shows the dimmer status after the AUX button has been pressed.

LED colour code:

Auto-capacitive	Continuous red → factory configuration
Forced capacitive	Flashing red
Auto-inductive	Continuous green
Forced inductive	Flashing green

7. TECHNICAL FEATURES

■ 7.1 Table of admissible loads

		R		L		C		C/L	
								Dimmable 	Dimmable 
									
240 V	Max.	400 W	400 W	400 VA	400 VA	400 VA	200 VA	150 W	150 W
	Min.	3 W	3 W	3 VA	3 VA	3 VA	3 VA	3 W	3 W
100 V	Max.	200 W	200 W	200 VA	200 VA	200 VA	100 VA	75 W	75 W
	Min.	3 W	3 W	3 VA	3 VA	3 VA	3 VA	3 W	3 W

Do not mix different load types on the same product

■ 7.2 Protection class

IP 40: assembled product
IP 20: without rocker plate
IK 02

■ 7.3 Material characteristics

Case: Polycarbonate
Rocker plate: ABS or PC
Halogen-free
UV resistance
Self-extinguishing: + 850°C / 30 s for insulating components holding in place live parts.
+ 650°C / 30 s for the other insulating components.

■ 7.4 Electrical characteristics

Voltage: 100 to 240 Vac
Frequency: 50-60 Hz
Consumption on standby: 0.1 W

■ 7.5 Climatic characteristics

Storage temperature: -10°C to +70°C
Usage temperature: 0°C to +35°C

8. MAINTENANCE

Clean the surface with a cloth.
Do not use: acetone, tar-removing cleaning agents or trichloroethylene.

Caution: Always test before using other special cleaning products.

9. STANDARDS AND APPROVALS

Compliant with installation and manufacturing standards.
See e-catalogue.