

Mosaic™ Connected switch without neutral with dimmer option

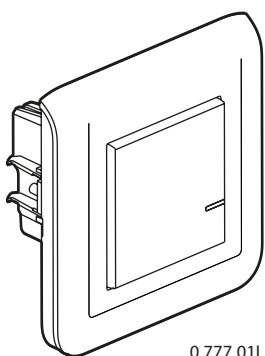

0 777 01L

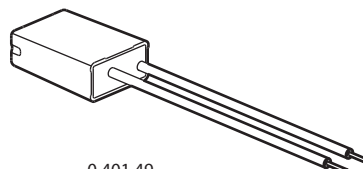

0 401 49

1. USE

Connected switch without neutral with dimmer option, configured by default as ON/OFF.

Can be combined with one or more wireless lighting controls (dimmer mode can be activated from the Home + Control app).

For local or remote control of your lighting.

Supplied with an active power compensator (Cat. No. 0 401 49), mandatory to ensure optimum operation with commercially-available lamps. One compensator per lighting circuit is sufficient.

Easy to install in place of a standard switch in a box 40 mm deep (minimum).

Claw and/or screw fixing.

2. RANGE

Description	White
Product for use in conjunction with the starter pack. With LED indicator (configuration) and RESET button (hidden) used to return to factory settings. Supplied complete with claws and site protection covers.	0 777 01L

3. DIMENSIONS (mm)

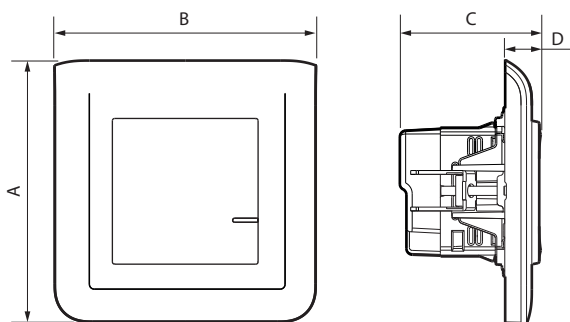

A	B	C	D
82	82	44.5	11.5

4. CONNECTION

Terminal type : screw

Terminal capacity: 2 x 1.5 mm² or 2 x 2.5 mm²

Stripping length:

8 mm flat screwdriver: 3 mm

5. OPERATION

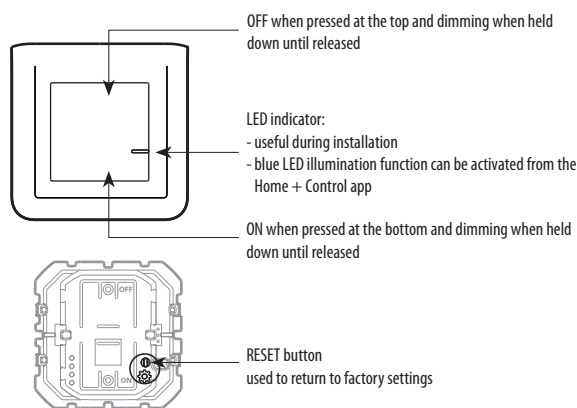

6. TECHNICAL CHARACTERISTICS

■ 6.1 Mechanical characteristics

Protection against impacts: IK 04

Protection against solid bodies/liquids: IP 41 assembled product

■ 6.2 Material characteristics

Plate: ABS + PC

Roker Plate: PC

Colour: White RAL 9003

Subplate: Opalescent White

Mechanism casing: PC

Grid: 6.6 PA + Galfan steel

Halogen-free

UV resistant

Self-extinguishing:

850°C/30 s for insulating parts holding live parts in place.

650°C/30 s for the other insulating components.

■ 6.3 Climate characteristics

Usage temperature: + 5°C to + 45°C

Storage temperature: 0°C to + 45°C

Connected switch without neutral with dimmer option

6. TECHNICAL CHARACTERISTICS (continued)











■ 6.4 Electrical characteristics

Voltage: 110/230 V~

Power: 300 W

Frequency: 50/60 Hz

Standby consumption: 0.2 W

		R	L			
			LED 			
						
240 V~	Max.	300 W	^(*) 60 W	60 W	300 VA	300 VA
	Min.	7 W	5 W	9 W	10 VA	35 VA
100 V~	Max.	150 W	^(*) 30 W	30 W	150 VA	150 VA
	Min.	7 W	5 W	9 W	10 VA	35 VA

^(*) Or 10 lamps max. For comfortable lighting, we recommend using bulbs of the same type and make.

^(**) The ferromagnetic transformers must be charged to more than 60% of their power. When calculating the permissible power, the ferromagnetic transformer efficiency must be taken into account. A load must be connected before programming and using the product.

Zigbee technology 2.4 GHz to 2.4835 GHz

Power level: < 100 mW

Range: 200 m of unobstructed space

10 m between products indoors

7. CARE

Clean the surface with a cloth.

Do not use acetone, tar-removing cleaning agents or trichloroethylene.

Resistant to the following products: Hexane (EN 60669-1), methylated spirit, soapy water, diluted ammonia, bleach diluted to 10%, window-cleaning products, pre-impregnated wipes.

Caution: Always test before using special cleaning products.

The plates must not be painted.

8. STANDARDS AND APPROVALS

Compliant with installation and manufacturing standards.

See e-catalogue.

The undersigned, LEGRAND, declares that the radio-electric equipment type (0 777 01L) complies with directive 2014/53/EU.

The full text of the EU declaration of conformity is available on the following website: www.legrandoc.com