

**B66**

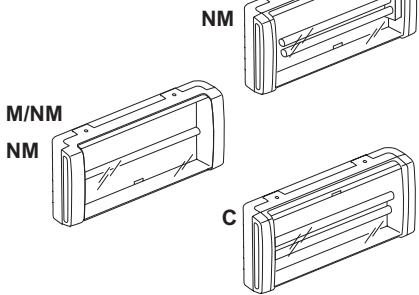

<b>6 615 01</b>	1h M	IP 66 – IK 08	100 lm	1 x TL8W
<b>6 615 02</b>	1h C	IP 66 – IK 08	100 lm	2 x TL8W
<b>6 615 11</b>	1h M	IP 66 – IK 08	200 lm	1 x TL8W
<b>6 615 12</b>	1h C	IP 66 – IK 08	200 lm	2 x TL8W
<b>6 615 21</b>	1h NM	IP 66 – IK 08	100 lm	1 x TL8W
<b>6 615 23</b>	1h NM	IP 66 – IK 08	250 lm	1 x TL8W
<b>6 615 25</b>	1h NM	IP 66 – IK 08	450 lm	1 x PL11W
<b>6 615 33</b>	2h NM	IP 66 – IK 08	260 lm	1 x TL8W
<b>6 615 35</b>	3h NM	IP 66 – IK 08	150 lm	1 x TL8W
<b>6 615 36</b>	3h M	IP 66 – IK 08	150 lm	1 x TL8W
<b>6 615 37</b>	3h C	IP 66 – IK 08	150 lm	2 x TL8W

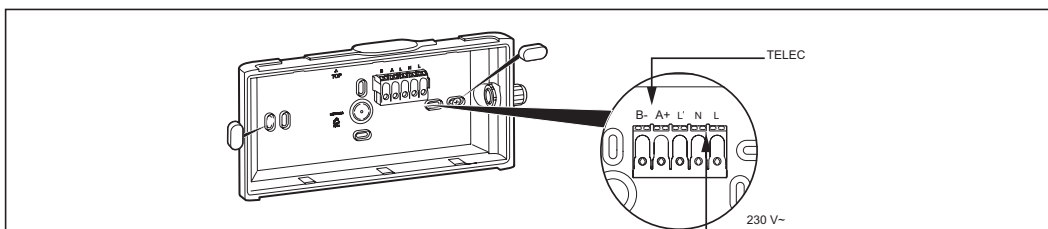
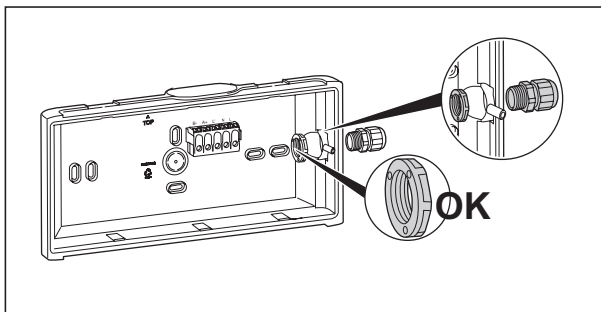
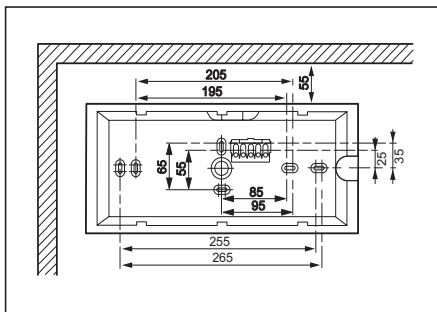

**Réf. 6 615 21/23/25/33/35 (NM)**

**Réf. 6 615 01/11/36 (M)  
6 615 02/12/37 (C)**

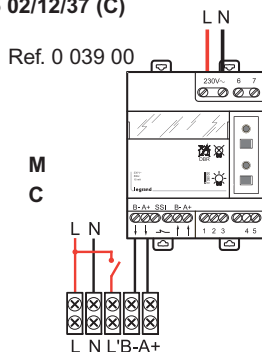
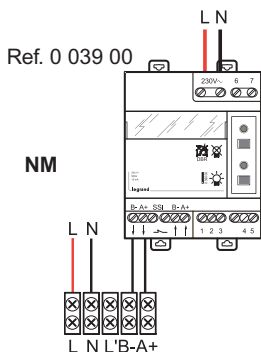

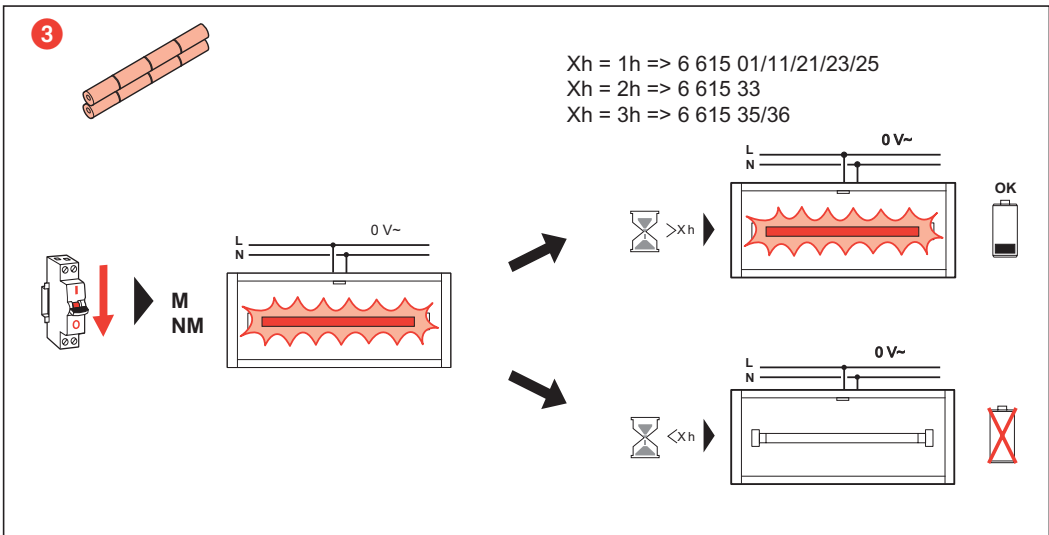
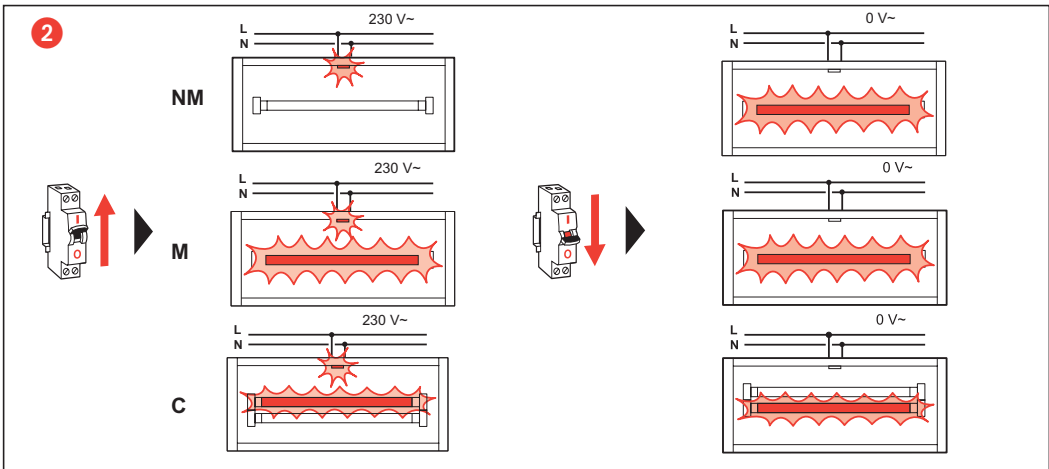
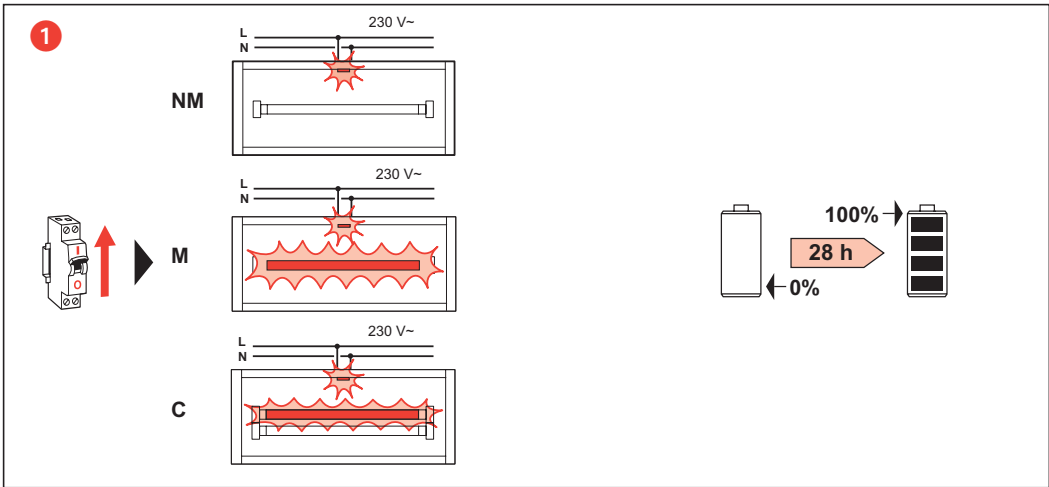

Xh = 1h => 6 615 02/12

Xh = 3h => 6 615 37

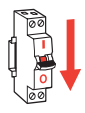

C

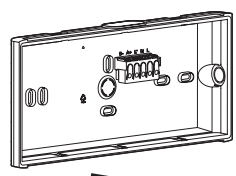
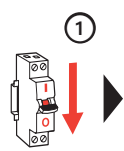
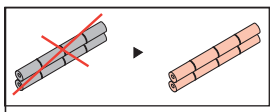
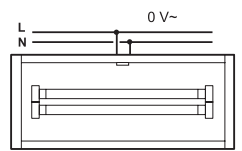
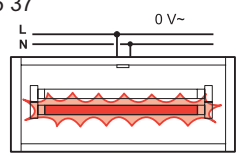
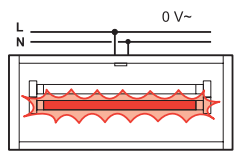

2

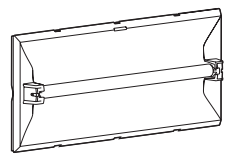

3

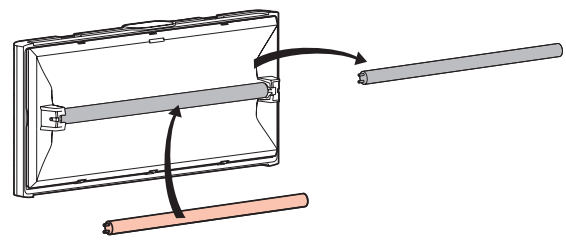
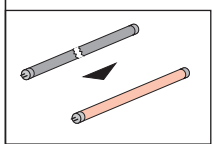
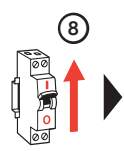
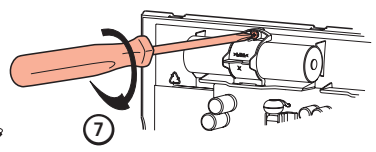
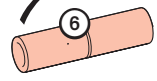
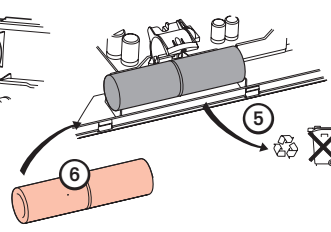
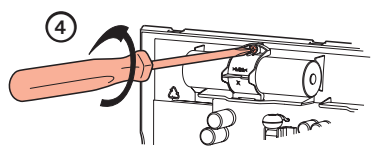
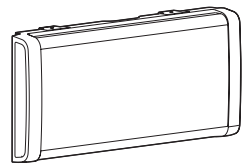

Ref. 6 621 99 (\*)

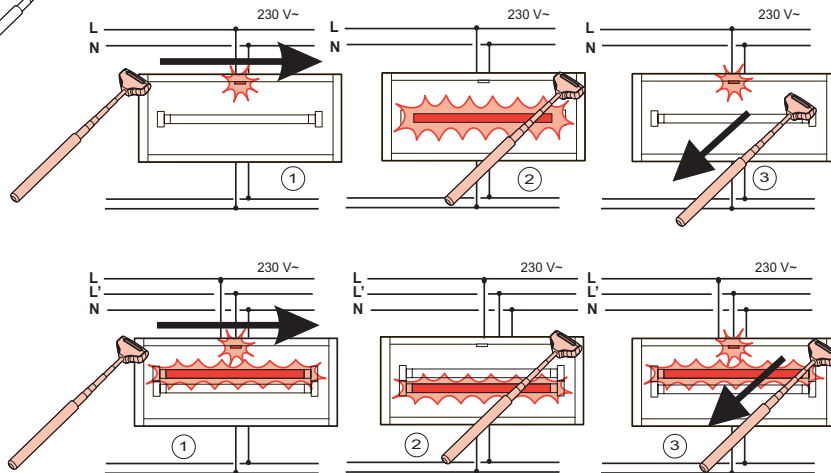
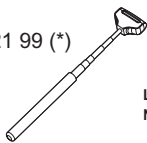

(\*) No comercializado en España

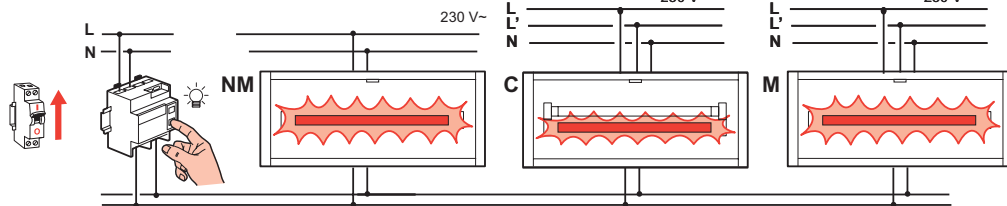

### ⚠️ Consignes de sécurité

Ce produit doit être installé conformément aux règles d'installation et de préférence par un électricien qualifié. Une installation et une utilisation incorrectes peuvent entraîner des risques de choc électrique ou d'incendie. Avant d'effectuer l'installation, lire la notice, tenir compte du lieu de montage spécifique au produit.

Ne pas ouvrir, démonter, altérer ou modifier l'appareil sauf mention particulière indiquée dans la notice. Tous les produits Legrand doivent exclusivement être ouverts et réparés par du personnel formé et habilité par Legrand. Toute ouverture ou réparation non autorisée annule l'intégralité des responsabilités, droits à remplacement et garanties.

Utiliser exclusivement les accessoires de la marque Legrand.

### ⚠️ Veiligheidsvoorschriften

Dit product moet in overeenstemming met de installatievoorschriften en bij voorkeur door een vakbekwame electricien worden geïnstalleerd. Bij een onjuiste installatie en een onjuist gebruik bestaat het risico van elektrische schokken of brand. Lees alvorens de installatie uit te voeren de handleiding door en houd rekening met de specifieke montageplaatjes van het product.

U mag het apparaat niet openen, demonteren of wijzigen, tenzij dat specifiek in de handleiding wordt vermeld. Alle Legrand-producten mogen uitsluitend worden geopend en gerepareerd door personeel dat door Legrand is opgeleid en bevoegd verklaard. In geval van ongeoorloofd openen of repareren wordt geen enkele aansprakelijkheid aanvaard, vervalt het recht op vervanging en zijn de garanties niet meer geldig. Gebruik uitsluitend accessoires van het merk Legrand.

### ⚠️ Safety instructions

This product should be installed in line with installation rules, preferably by a qualified electrician. Incorrect installation and use can lead to risk of electric shock or fire. Before carrying out the installation, read the instructions and take account of the product's specific mounting location.

Do not open up, dismantle, alter or modify the device except where specifically required to do so by the instructions. All Legrand products must be opened and repaired exclusively by trained and approved by Legrand. Any unauthorised opening or repair completely cancels all liabilities and the rights to replacement and guarantees.

Use only Legrand brand accessories.

### ⚠️ Sicherheitshinweise

Dieses Produkt darf nur durch einen Elektro-Fachkraft eingebaut werden. Bei falschem Einbau bzw. Umgang besteht das Risiko eines elektrischen Schlages oder Brandes.

Vor der Installation die Anleitung lesen, den produktspezifischen Montageort beachten. Das Gerät vorteilhaftlich besonders, in der Betriebsanleitung angegebener Hinweise nicht öffnen, zerlegen, beschädigen oder abändern. Alle Produkte von Legrand dürfen ausschließlich von durch Legrand geschultes und anerkanntes Personal geöffnet und repariert werden. Durch unbefugte Öffnung oder Reparatur erlöschen alle Haftungs-, Ersatz- und Gewährleistungsansprüche. Ausschliesslich Zubehör der Marke Legrand benutzen.

### ⚠️ Instruções de segurança

Este produto deve ser instalado de acordo com as regras de instalação e de preferência por um electricista qualificado. A instalação e o uso incorrectos podem provocar riscos de choque eléctrico ou de incêndio.

Antes de efectuar a instalação, ler as instruções e ter em conta a localização adequada para a montagem do produto.

Não abrir, desmontar, alterar ou modificar o aparelho salvo especificação em contrário nas instruções do produto. Todos os produtos Legrand só devem ser abertos e reparados exclusivamente por pessoal formado e autorizado pela Legrand. Qualquer abertura ou reparação não autorizada cancela todas as responsabilidades, direitos de substituição e garantias. Utilizar exclusivamente os acessórios da marca Legrand.

### ⚠️ Biztonsági előírások

A terméket csak vilamos szakember szerelheti fel. A szakszerűtlen felszerelés és használat áramütés vagy elektromos tűz kockázatával jár.

Felszerelés előtt olvassa el a használati utasítást, vegye figyelembe a termékspecifikus szerelési körülményeket. Ne szedje szét a terméket. Legrand terméket kizárólag a Legrand által képzett és elismert szakember szerelheti szét és javíthatja meg. Illetéktelen személy által történt beavatkozás esetén minden garancia, cseré vagy szavatossági igény megszűnik. Csak eredeti Legrand tartozékokat használjon.

### ⚠️ Sikkerhedsregler

Dette produkt skal installeres i overensstemmelse med retningslinjer for installation og helst installeret af en kvalificeret elektriker. Ukorrekt installation eller brug kan medføre fare for elektrisk stød eller brand.

Inden installationen foretages, skal betjeningsvejledningen læses, og der skal tages hensyn til de specielle forhold på det sted, produktet skal monteres. Apparatet må ikke åbnes, afmonteres, ombygges eller ændres mindre det er særligt angivet i vejledningen. Alle Legrand produkter må kun åbnes og repareres af uddannede og autoriseret Legrand personale. Al ikke autoriseret åbning eller reparation ophæver alt ansvar, samt al ret til udskiftning eller garanti. Der må kun benyttes tilbehør af mærket Legrand.

### ⚠️ Consignas de seguridad

Este producto debe instalarse conforme a las normas de instalación y preferiblemente por un electricista cualificado. Una instalación y una utilización incorrectas pueden entrañar riesgos de choque eléctrico o de incendio. Antes de efectuar la instalación, leer las instrucciones, tener en cuenta el lugar de montaje específico del producto.

No abrir, desmontar, alterar o modificar el aparato salvo que esto se indique específicamente en las instrucciones. Todos los productos Legrand deben ser abiertos y reparados exclusivamente por personal formado y habilitado por Legrand. Cualquier apertura o reparación no autorizada anula la totalidad de las responsabilidades, derechos a sustitución y garantías. Utilizar exclusivamente los accesorios de la marca Legrand.