

Canalisations électriques préfabriquées MR

Cotes d'encombrement

Canalisations

160 à 315 A

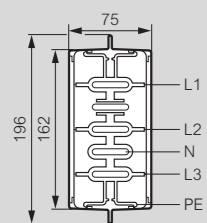

400 à 1000 A

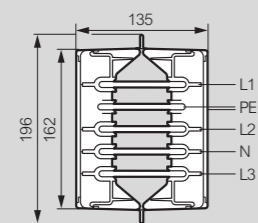

3 + 3 fenêtres de dérivation

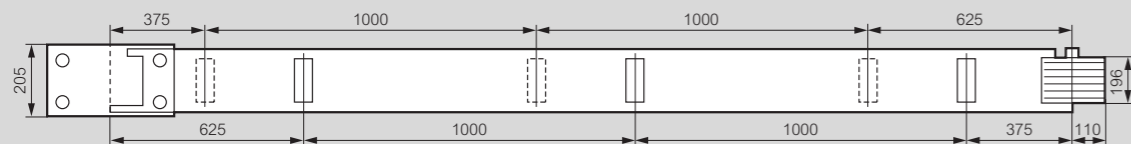

5 fenêtres de dérivation (sur un côté)

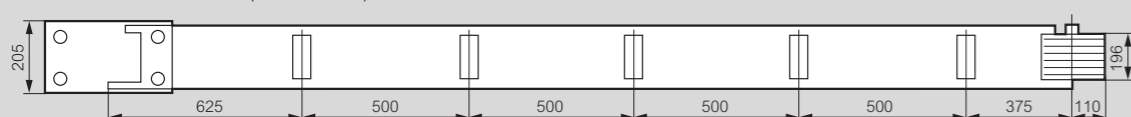

160 à 315 A

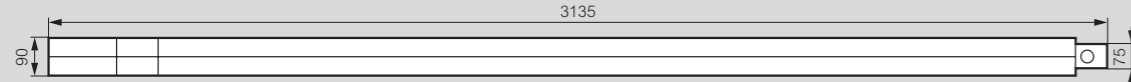

400 à 1000 A

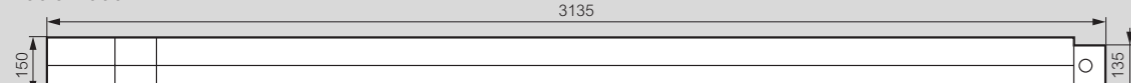

Coudes horizontaux

Type A

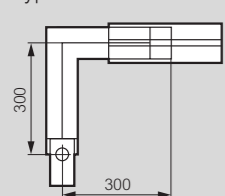

Type B

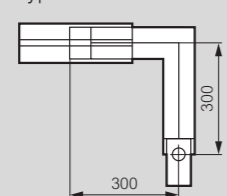

Coudes verticaux

Type A

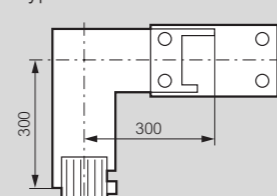

Type B

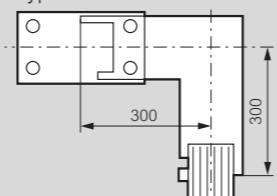

Boîtiers et coffrets d'alimentation

Réf. ZU50401111/12

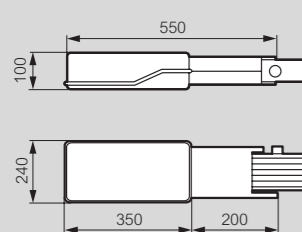

Réf. ZU50401101/02

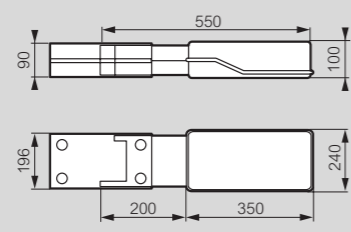

Réf. ZU50401121/22/23 et ZU50411124/28/25/26/27

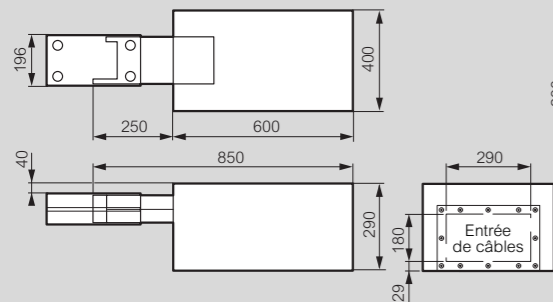

Réf. ZU50401201/02/03/04/08/05/06/07

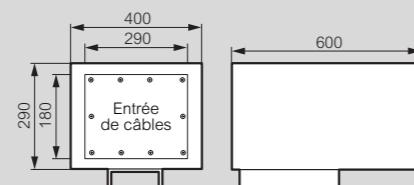

Réf. ZU50401131/32/33 et ZU50411134/38/35/36/37

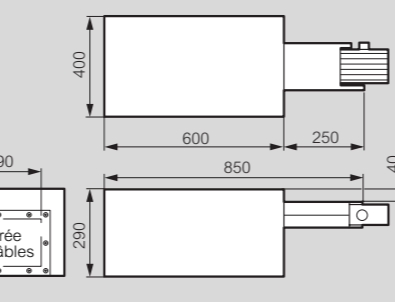

Boîtiers de dérivation

Réf. ZU50414061/64/62 + ZU50414128/44/42

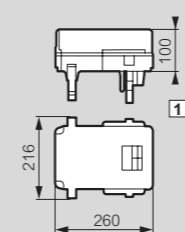

Réf. ZU50414071/75 + ZU50414187/92

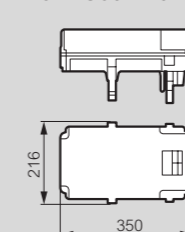

Boîtiers de dérivation débrochables à sectionnement

Réf. ZU55655051

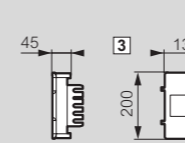

Réf. ZU55055052/53/57/86/88/56/68/66 + ZU50404004/24

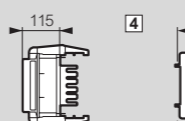

Réf. ZU50414021/22/23/01/02/03 + ZU50411601/22/23

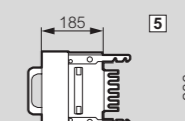

Réf. ZU50414004/24 + ZU50411624

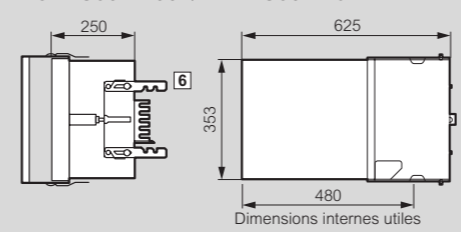

Réf. ZU50414005/26/25 + ZU50411625/46

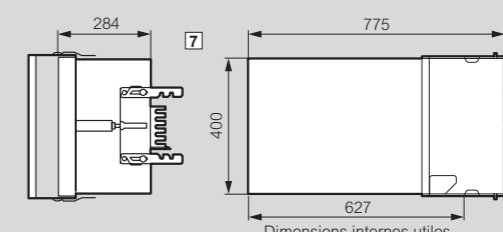

Montage de boîtiers de dérivation

Pose horizontale

Eléments 3 + 3 fenêtres :
réf. ZU50400101 à ZU50410108

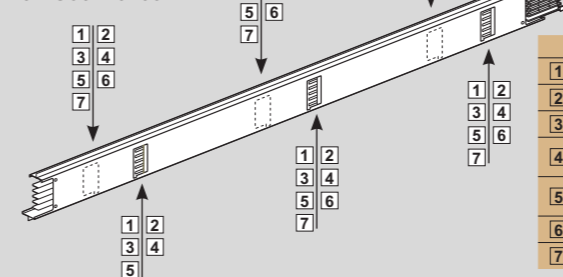

Réf. boîtier de dérivation	
1	ZU50414061/62 + ZU50414128/42/44
2	ZU50414071/75 + ZU50414187/92
3	ZU55655051
4	ZU55055052/53/56/57/66/68/86/88 + ZU50404004/24
5	ZU50414021/22/23/01/02/03 + ZU50411601/22/23
6	ZU50414004/24 + ZU50411624
7	ZU50414005/25/26 + ZU50411625/46

Eléments 5 fenêtres : réf. ZU50400251 à ZU50410258

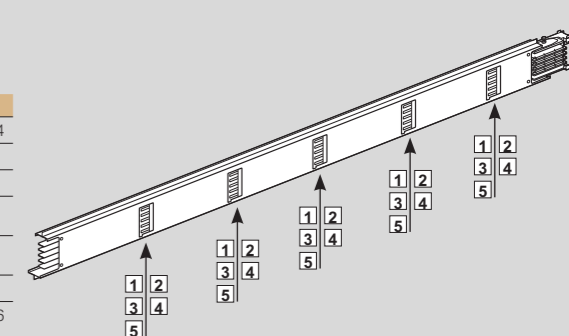

Application en colonne montante

Eléments 3 + 3 fenêtres : réf. ZU50400101 à ZU50410108 + réf. ZU50403711/12

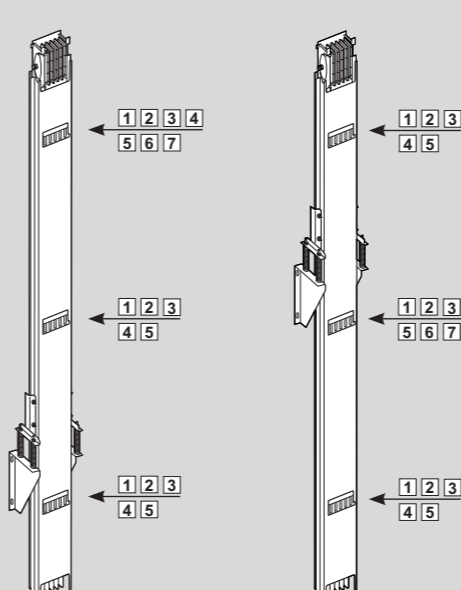

Eléments 5 fenêtres : réf. ZU50400251 à ZU50410258 + réf ZU50403711/12

