

# DMX<sup>3</sup> 2500 et DMX<sup>3</sup>-I 2500 - taille 1

## dimensions

### Version fixe - taille 1

#### Cotes d'encombrement

3P

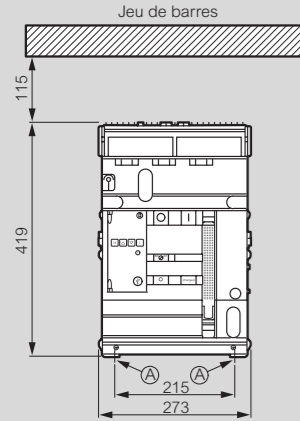

4P

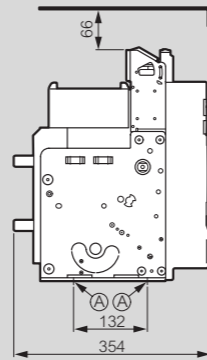
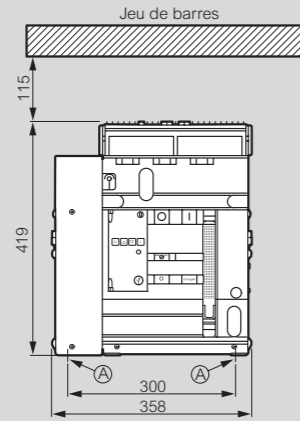

A = points de fixation sur la platine de montage

#### Principe de raccordement

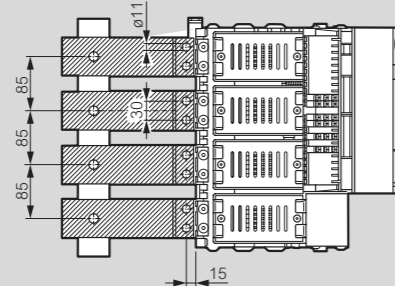
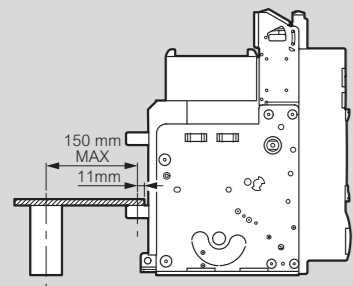

#### Prises arrière pour raccordement vertical

Réf. 0 288 82/83

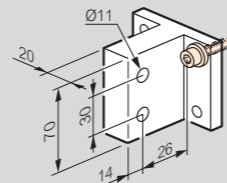

#### Prises arrière pour raccordement horizontal

3P

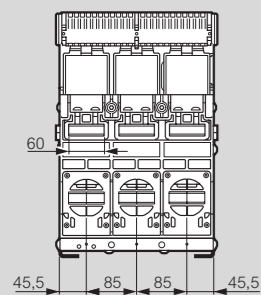

4P

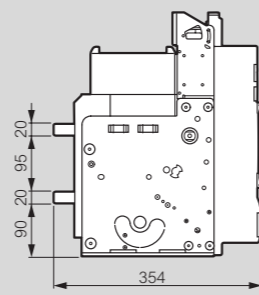
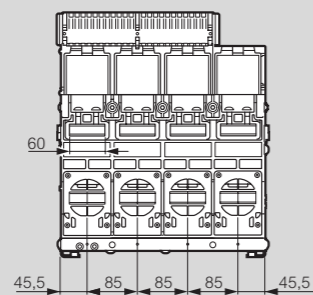

#### Épanouisseurs pour raccordement à plat

Réf. 0 288 86/87

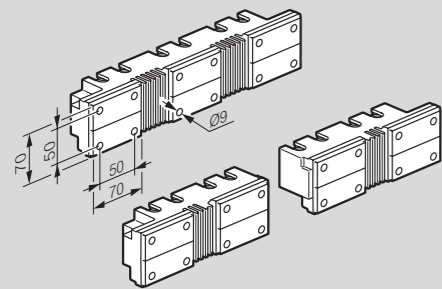

#### Épanouisseurs pour raccordement vertical

Réf. 0 288 88/89

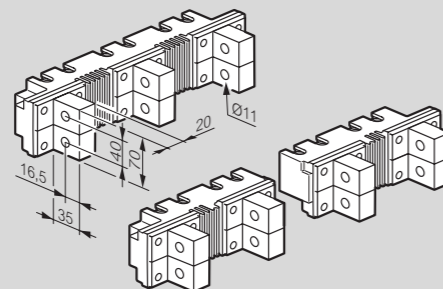

#### Épanouisseurs pour raccordement horizontal

Réf. 0 288 90/91

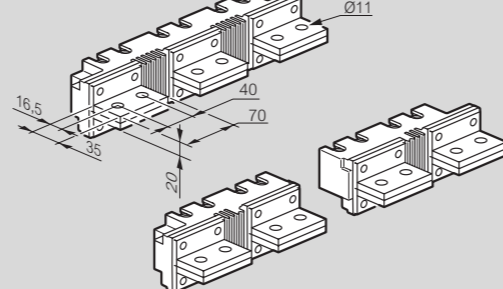

### Version débrochable - taille 1

#### Cotes d'encombrement

3P

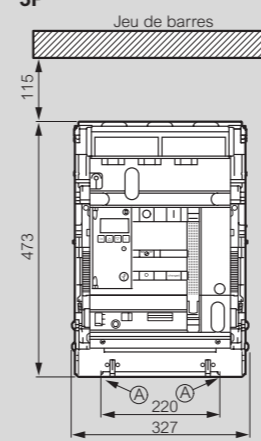

4P

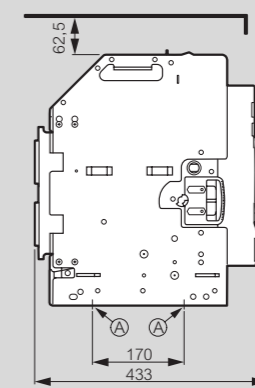
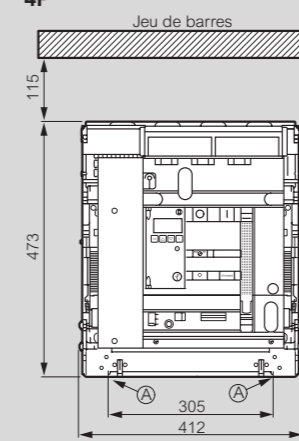

A = points de fixation sur la platine de montage

#### Prises arrière pour raccordement à plat

3P

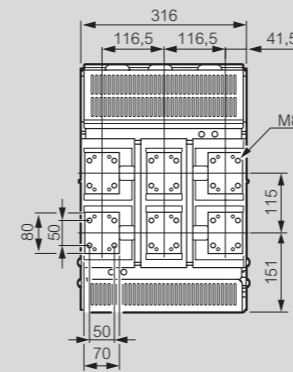

4P

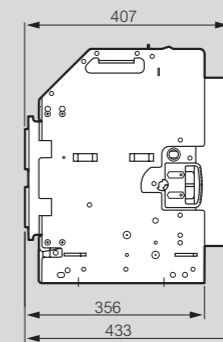
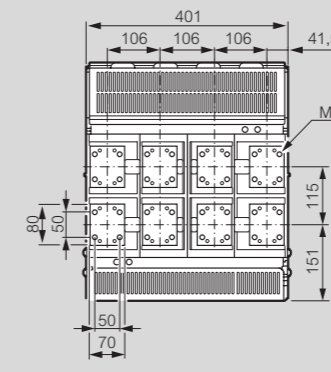

#### Prises arrière pour raccordement horizontal - Réf. 0 288 96/97

3P

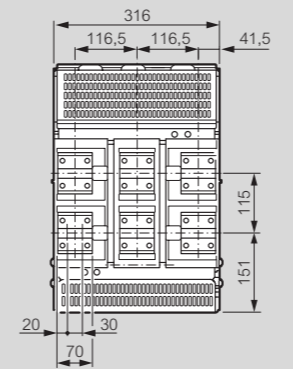

4P

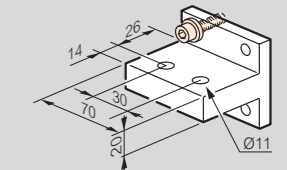
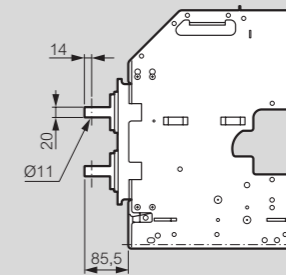
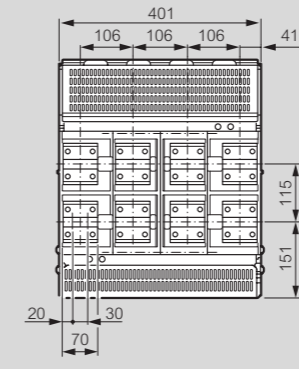

#### Prises arrière pour raccordement vertical - Réf. 0 288 96/97

3P

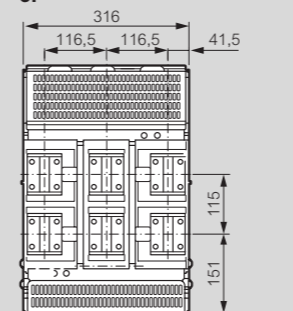

4P

